

# Mid-West Instrument

MADE IN  
THE U.S.A.

**DIFFERENTIAL PRESSURE GAUGES  
SWITCHES & TRANSMITTER**

Providing product  
& solutions  
since 1958

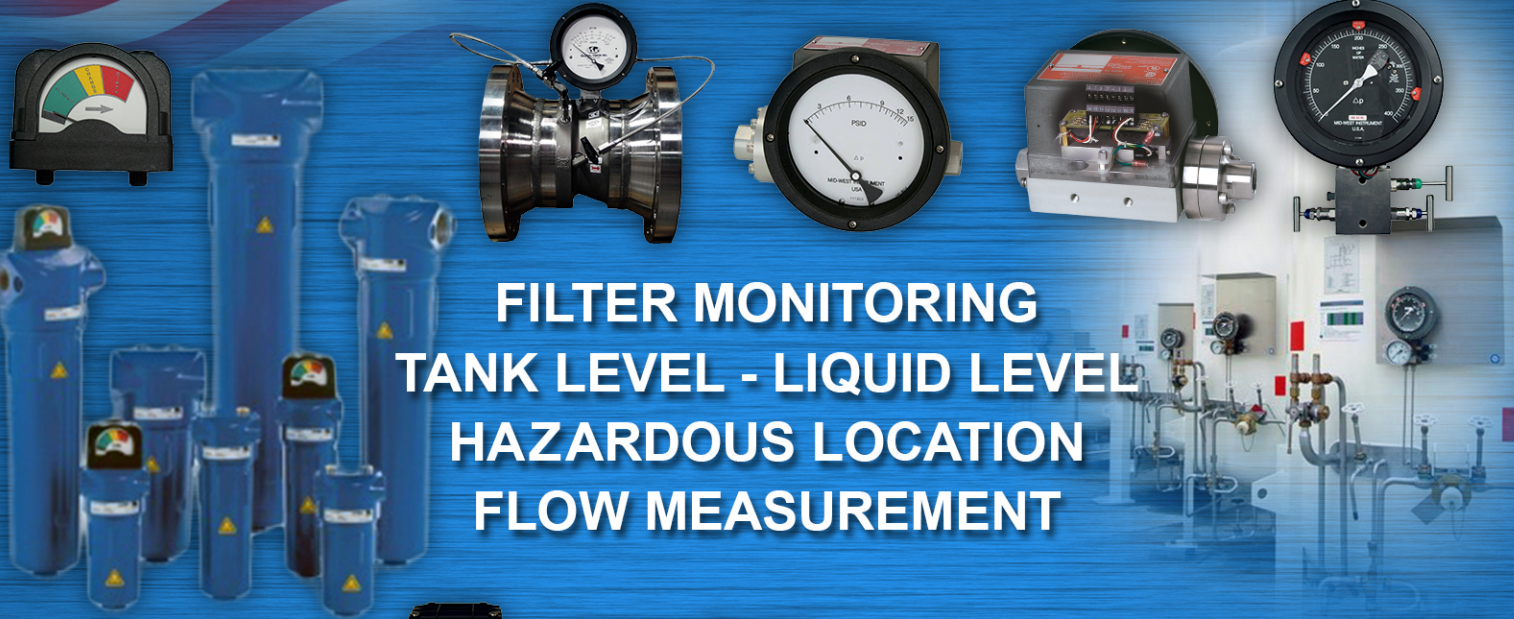

**FILTER MONITORING  
TANK LEVEL - LIQUID LEVEL  
HAZARDOUS LOCATION  
FLOW MEASUREMENT**

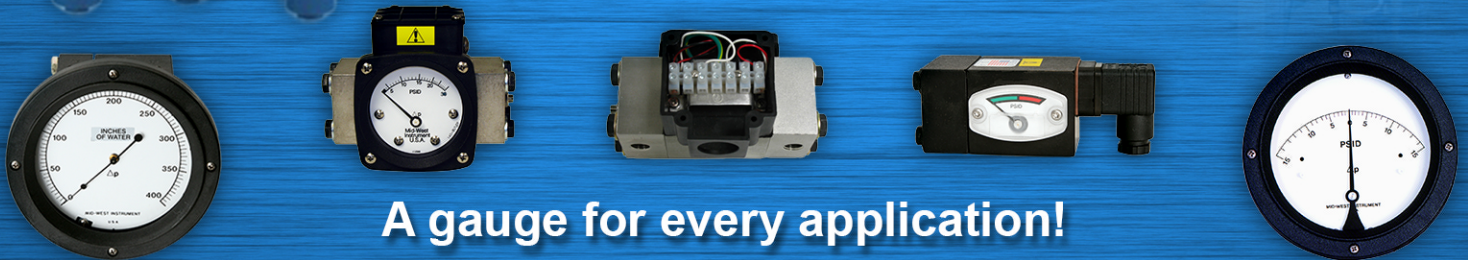

**A gauge for every application!**

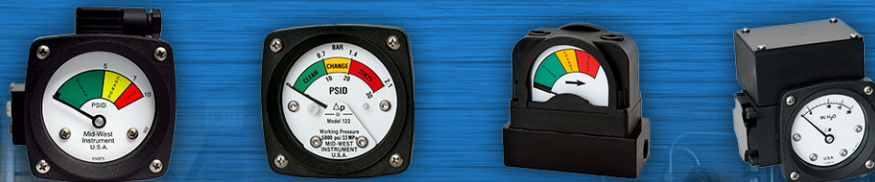

# Mid-West<sup>®</sup> Instrument

## 1 Year & 5 Year Product Warranties

Manufacturer warrants that all products sold shall be free from defects in workmanship and material for warranty period.

Manufacturer does not make any other warranties and expressly disclaims all other warranties, expressed or implied, the uniform commercial code, as adopted in the State of Michigan. Without limiting the generality of the foregoing, manufacturer expressly disclaims any warranty of merchantability, and any warranty of suitability or fitness for any particular or intended purpose or use. The sole and exclusive remedy shall be limited to replacement or repair of any product which has a defect in workmanship or material. In no event shall manufacturer be liable to any representative, distributor, customer, ultimate user or any other person or entity for any damages, costs, expenses or liabilities of any kind or nature, including, without limitation, direct damages, indirect damages, consequential damages, labor cost, and any expenses incurred by any distributor, customer, ultimate user or any other person or entity relating to the installation, use, repair or replacement of any product. This product warranty and disclaimer shall apply to all sales of products.

**Warranty Period is dependant on product purchased**

**Please contact the sales department for complete product warranty details.**

*Providing DP Solutions for*

*over 50 Years*

# Mid-West<sup>®</sup> Instrument

## STANDARD POLICIES and CONDITIONS OF SALE

1. **Acceptance** – Quotations are firm for 30 days unless otherwise specifically noted. All orders are subject to acceptance by Mid-West Instrument at our plant.
2. **Shipping Dates** – The scheduled shipping date is established from the date we have all information necessary to properly process the subject order. Mid-West assumes no responsibility for any delays in shipment, for any reason
3. **Dimensional Data and Specifications** – Information shown in Mid-West literature is general only and the right is reserved to change dimensions or specifications, etc., at any time
4. **Methods of Shipment** – Unless otherwise specified, Mid-West's standard methods of shipment are:
  - United Parcel Service
  - United Parcel Service "Hundred Weight" Service
  - Commercial Carrier**(NOTE: No freight bills are available on shipments by United Parcel Service. Saturday deliveries require customer contact name and phone number)**
5. **Shipping Charges and F.O.B. Point** – All shipments are F.O.B. our plant, Sterling Heights, Michigan. If shipping charges are to be prepaid and added to the invoice, Mid-West reserved the right to estimate these charges. Title to invoiced items transfers upon delivery to the carrier.
6. **Notification of Shipment Charges** - A \$10.00 service charge will be added to all orders requiring telephone, telegraph, etc., notification of shipment.
7. **Export Documentation Charges** – A minimum charge of \$75.00 will be added to all orders requiring export documentation.
8. **Minimum Order** - \$75.00 NET
9. **Cancellation and Returns** – None may be made by a purchaser without prior authorization by Mid-West, and all return shipments must be prepaid. Collect shipments will be refused.
10. **Terms**- Net 30 Days after invoice date upon approved credit.  
A service charge of 1-1/2% per month will be applied to all accounts over 30 days past due. This is a rate of 18% per year.

# Mid-West<sup>®</sup> Instrument

*Making the right decision for all your  
Differential Pressure Applications*



## "Piston" Type Gauge

**Piston** type:  $\pm 2\%$  or  $\pm 5\%$  Full Scale Accuracy. They are primarily designed for liquid applications. They exhibit a slight amount of bypass as the fluid crosses from the high to the low pressure port. Because gas molecules are smaller, the crossover is often deemed too great for the application. The Differential Pressure is sensed by the movement of a precisely ground floating piston/magnet in a precision bore against a calibrated spring. Any variation in pressure on either side of the piston/magnet will cause the magnet to move proportionally to the change in differential pressure. A rotary pointer magnet located close to the internal magnet, but outside the pressure housing, follows the movement of the piston magnet and indicates differential pressure on the dial. Piston type DP gauges exhibit a slight amount of bypass as the fluid crosses from the high to the low pressure port. Due to precision sizing of piston and body bore, leakage across the piston will not exceed 15 SCFH air at 100 PSID at ambient conditions.

Piston-Type Differential Pressure Gauges are available with one or two hermetically sealed reed switches or 4-20mA transmitter depending on model. The switches are adjustable within a defined percentage of the full scale range of the gauge and are available in SPDT and SPST, normally open or normally closed configurations for various load/power ratings. The switches can be set to activate or deactivate on rising or falling pressure. Switches are "CE" marked per the EU low voltage directive. Models 120, 121, & 123 can be configured for use in hazardous locations. All hazardous location switches are both CSA and UL listed. The CSA & UL listings are for the entire assembly and not just the enclosure.

## "Diaphragm" Type Gauge

**Diaphragm** type:  $\pm 2\%$  or  $\pm 5\%$  Full Scale Accuracy. The high and low-pressure ports are completely isolated from each other. There is no bypass and therefore they are ideally suited for use on dissimilar fluids, air, gases, or liquids with a high concentration of solids, etc. They also come in a variety of sizes allowing for very sensitive measurements. The Differential Pressure is sensed by the movement of an elastomer diaphragm against a precision calibrated range spring. The change in position of the diaphragm in response to the change in Differential Pressure moves an internal magnet. This magnet, in turn, causes a rotary magnet external to the gauge body to rotate. This rotary magnet has a pointer attached which indicates the differential pressure on the dial.

Diaphragm-Type Differential Pressure Gauges are available with one or two hermetically sealed reed switches or 4-20mA transmitter depending on model. The switches are adjustable within a defined percentage of the full scale range of the gauge and are available in SPDT and SPST, normally open or normally closed configurations for various load/power ratings. The switches can be set to activate or deactivate on rising or falling pressure. Switches are "CE" marked per the EU low voltage directive. Mid-West Diaphragm-type Differential Pressure Gauges can be configured for use in hazardous locations. All Hazardous Location Switches are both CSA and UL listed. The CSA & UL listings are for the entire assembly and not just the enclosure.

## “Bellows” Type Gauge

**Bellows type:** -  $\pm 1/2\%$  or  $\pm 1\%$  Full Scale Accuracy. System pressure is applied to the internal volume of a bellows and mechanical linkage assembly. As pressure changes, the bellows and linkage assembly move to cause an electrical signal to be produced or to cause a gauge pointer to move. The major components of the Model's 105/106/115 and 116 are a two-piece body, bellows sensing element and over-pressure assembly, a torque tube assembly, a range spring and the gauge front assembly.

The body halves provide the pressure containment function. They also clamp the sensing element and over-pressure assembly between the halves, isolating the high side and low side pressures of the system. The high side body half also provides a mount for the torque tube assembly and the gauge front assembly.

The sensing element is exposed to the differential pressure and deflects in response to the differential pressure. This assembly incorporates a bidirectional relief valve which provides over-pressure protection in both directions. When over-pressured from the high side, the valve is opened by a mechanical stop as the sensing element deflects to its maximum travel. When over-pressured from the low side, the spring-loaded valve opens when the differential pressure exceeds its maximum rating.

The opening of the valve in either direction equalizes the pressure and protects the unit. A range spring is provided to adjust the spring rate of the system to suit the various differential pressure ranges of the instrument. **NOTE:** The use of diaphragm seals is not recommended for model 105/106 series gauge. Attempts to install such seals on these gauges will void the warranty.

## “Bourdon Tube” Type Gauge

**Bourdon Tube type** -  $\pm 1/2\%$  or  $\pm 1\%$  Full Scale Accuracy. System pressure is applied to the inside of a slightly flattened arc-shaped tube. As pressure increases, the tube tends to restore to its original round cross-section. This change in cross-section causes the tube to straighten. Since the tube is permanently fastened at one end, the tip of the tube traces a curve that is the result of the change in angular position with respect to the center.

Mid-West Model 109 is powered by a test quality Bourdon Tube Assembly. The assembly is encapsulated in a high pressure chamber that is fitted with a pressure connection to the inside of the Bourdon Tube and a second connection to the pressure chamber. The Model 109 indicates the difference between the pressure applied inside the Bourdon Tube and the pressure inside the chamber.

The pressure chamber for the assembly is small, close fitting and rugged. The volume displacement of the Bourdon Tube through the pressure range is near to zero (0.02 c.c.). The speed of response of the indicator to changes in differential pressure is instantaneous, even on low volume pressure systems. The low volume displacement is an important advantage for differential pressure leak detection, and when isolation diaphragms are required.

The Bourdon Tube Assembly is protected against over-range in either direction to the rated working pressure by a bi-directional relief valve. The output shaft of the gauge assembly is magnetically coupled through the solid wall of the pressure chamber to a sensitive jeweled pointer shaft in the dial housing outside the chamber. The magnetic coupling transmits the exact motion of the assembly to the pointer to give an accurate dial reading of the differential pressure. **NOTE:** The use of diaphragm seals is not recommended for Model 109 series gauge. Attempts to install such seals on these gauges will void the warranty.

# Mid-West<sup>®</sup> Instrument

## Differential Pressure Gauges, Switches & Transmitters



**BELLOWS & BOURDON TUBE TYPE:**  
Models 105/106/116 bellows design and Model 109 encapsulated Bourdon tube design provide a simple and highly accurate differential pressure gauge. Gauge Housings available in Aluminum, Brass, Carbon Steel and Stainless Steel 316/316L

**PISTON TYPE:** Differential pressure gauges and switches for use on filters, strainers, pumps etc. Available with one or two hermetically sealed reed switches in SPDT and SPST. Some units also available with 4-20 mA Transmitter. Gauge Housings available in Aluminum, 316/316L Stainless Steel, Aluminum Bronze and Monel



**DIAPHRAGM TYPE:** Ideally suited for use on dissimilar fluids and wet gas or fluids with a high concentration of solids, etc. Available with one or two hermetically sealed reed switches in SPDT and SPST. Some units also available with 4-20 mA Transmitter. Gauge Housings available in Aluminum, Brass, 316/316L Stainless Steel, Aluminum Bronze and Monel

**HAZARDOUS LOCATION SWITCHES**  
Switching components are housed under a copper free Aluminum cover. The combination of the gauge body and the cover make up the flame-proof seal. Switches are available with 1 or 2 hermetically sealed reed switches with SPDT, SPST or DPDT relay outputs. 4-20mA Transmitter also available. Wetted parts are Aluminum or Stainless Steel



**"O. E. M." INDICATORS & GAUGES**  
Competitively price differential Pressure Indicators, Gauges & Switches for the O.E.M customer. Housings available in Glass reinforced Plastic, Aluminum and Stainless Steel. Working pressure of 300, 1,000 and 3,000 PSIG

**FLOW INSTRUMENTATION**  
Model 300 Averaging Pitot Tube and Models 105, 106, 130, 140, and 142 Differential Pressure gauges all available with Flow Dials.  
Series 800 Flow Test Kits



Series 800 Flow Test

### 3 & 5 VALVE DIFFERENTIAL PRESSURE MANIFOLD

Stainless Steel differential pressure manifolds.  
 6,000 PSIG Maximum Working Pressure rated.  
 Temperature rating 200°F.  
 Process Connections: ½" FNPT & ¼" FNPT  
 Available Individually or Direct Mounted to your DP Gauge.



#### PULSATION DAMPENER

Model 150 provides infinitely adjustable dampening.  
 Protects against surges and pressure shocks.  
 Available with Brass or Stainless steel bodies.

#### PRESSURE LIMITING VALVE

Model 200 pressure limiting valve prevents instrument over-range.  
 Adjustable needle valve dampens pulsation.  
 Available with Brass, Aluminum or Stainless steel bodies.

### QUICK REFERENCE GUIDE

Model Number	Sensor Type	Minimum Range	Maximum Range	Accuracy % Full Scale	Maximum Temp. (F)	MWP (PSIG)
105	Bellows	0-10" H2O	0-79.9" H2O	±1/2% or 1%	200°F	500 to 6,000
106	Bellows	0-80" H2O	0-800" H2O	±1/2% or 1%	200°F	500 to 6,000
109	Bourdon Tube	0-15 PSID	0-6000 PSID	±1/2% or 1%	200°F	500 to 6,000
116	Bellows	0-80" H2O	0-800" H2O	±1%	200°F	500 or 1,000
120	Piston	0-5 PSID	0-110 PSID	±2%	200°F	3,000 to 6,000
121	Piston	0-5 PSID	0-110 PSID	±2%	200°F	3,000 to 6,000
122	Piston	0-5 PSID	0-110 PSID	±5%	200°F	3,000
123	Piston	0-150 PSID	0-400 PSID	±2%	200°F	3,000 to 5,000
124	Piston	0-5 PSID	0-400 PSID	±2%	200°F	10,000
130	Diaphragm	0-5" H2O	0-400" H2O	±5% or 2% (based on range)	200°F	300 or 500
140	Diaphragm	0-50" H2O	0-100 PSID	±2%	200°F	1,500 or 3,000
142	Diaphragm	0-20" H2O	0-25 PSID	±2%	200°F	1,500 or 3,000
522	Diaphragm	0-5 PSID	0-50 PSID	±5%	200°F	1,000
555A	Diaphragm	0-2.0 PSID	0-43 PSID	±5%	200°F	300
700	316L S.S. Diaphragm	0-5 PSID	0-300 PSID	±0.50%	175°F	See Bulletin
<b>Hazardous Location Switches</b>						
220	Piston	0-5 PSID	0-100 PSID	±2%	200°F	4,000
240	Diaphragm	0-20" H2O	0-100 PSID	±2%	200°F	1,500
<b>O. E. M Gauges</b>						
126	Piston	0-5 PSID	0-20 PSID	±5%	200°F	3,000
127	Piston	0-25 PSID	0-100 PSID	±5%	200°F	3,000
146	Diaphragm	0-50" H2O	0-30 PSID	±5%	200°F	1,000
444	Slider Indicator	0-5 PSID	0-25 PSID	±5%	200°F	300
555	Diaphragm	0-2.0 PSID	0-50 PSID	±5%	200°F	300
522	Diaphragm	0-5 PSID	0-50 PSID	±5%	200°F	1,000
<b>FLOW Instrumentation</b>						
Model 300 Delta Tube						
Series 800 Flow Test Kits						
<b>Accessories</b>						
Three & Five Valve S.S. Differential Pressure Manifolds						
Model 150 Pulsation Dampener						
Model 200 Pressure Limiting Valve						
Diaphragm / Chemical Seals						

# Mid-West<sup>®</sup> Instrument

## Gauges, Switches & Transmitters

### “PISTON” Gauge

(±2% & ±5% Full Scale Accuracy)

Model 120, 121, 122, 123, & 124...(0-5 PSID to 0-110 PSID / 0-150 PSID to 0-400 PSID).....  
Model 220 Hazardous Location Switch...(0-5 PSID to 0-100 PSID).....

### “DIAPHRAGM” Gauge

(±0.50%, ±2% & ±5% Full Scale Accuracy)

Model 130, 140, & 142...(0-5” H<sub>2</sub>O to 0-100 PSID).....  
Model 240 Hazardous Location Switch...(0-5 PSID to 0-100 PSID).....  
Model 522... (0-5 PSID to 0-50 PSID).....  
Model 522A.. (3 Color Dial)...(0-5 PSID to 0-50 PSID).....  
Model 555A .(3 Color Dial).DP Indicator (0-3 PSID to 0-43 PSID).....  
Model 700... Transmitter.(0-5 PSID to 0-300 PSID).....

### “BELLOWS” Gauge

(±1/2% & ±1% Full Scale Accuracy)

Model 105 & 106...(0-10” H<sub>2</sub>O to 0-800” H<sub>2</sub>O) / (0-4 PSID to 0-30 PSID).....  
Model 105 Hydrogen (0-10” H<sub>2</sub>O to 0-50” H<sub>2</sub>O) / (0-25 mbar to 0-125 mbar).....

### “BOURDON TUBE” Gauge (±1/2% & ±1% Full Scale Accuracy)

Model 109...(0-15 PSID to 0-6000 PSID).....

### “TANK LEVEL” Gauge

(±1% & ±2% Full Scale Accuracy)

Model 115 & 116 “Metal Bellows Style” ±1%...(0-10” H<sub>2</sub>O to 0-800” H<sub>2</sub>O).....

### “Flow” Instrumentation

800 Series (Flow Test Kits).....  
Delta Tube Model 300 (Averaging Pitot Tube).....

### “O.E.M” Gauges

(±5% Full Scale Accuracy)

Model 126 & 127(Piston Type)...(0-5 PSID to 0-20 PSID / 0-25-PSID to 0-100 PSID).....  
Model 146 (Diaphragm Type)...(0-50” H<sub>2</sub>O to 0-30 PSID).....  
Model 444 Slider Indicator...(0-5 PSID to 0-25 PSID).....  
Model 555 DP Indicator...(0-3.5 PSID to 0-43 PSID).....  
Model 522 (Diaphragm Type)...(0-5 PSID to 0-50 PSID).....

### “ACCESSORIES”

3 & 5 Valve Block Manifolds.....  
Model 150 Pulsation Dampener.....  
Model 200 Pressure Limiting Valve.....  
Diaphragm / Chemical Seals.....



# PISTON STYLE GAUGE

---



For Installation and Operation Manuals  
Please Visit: [www.midwestinstrument.com/literature](http://www.midwestinstrument.com/literature)

---

**Mid-West**  
Instrument



# Mid-West<sup>®</sup> Instrument

## “Piston Type”

### Differential Pressure Gauges Switches & Transmitters

## Model 120



**A low cost differential pressure gauge for use in measuring the pressure drop across filters, strainers, separators, valves, pumps, chillers, etc., and for local flow indication and control.**



Model 120  
0-50 PSID  
2-1/2" Dial

Due to precision sizing of piston and body bore, leakage across piston will not exceed 15 SCFH air at 100 PSID at ambient temperature.

- Simple, rugged, compact design.
- Working pressures up to 6,000 PSIG (400 bar)
- Over-range protection to maximum pressure.
- Body Materials: Aluminum or 316L Stainless Steel with 316 stainless steel internals. Aluminum Bronze & Monel available upon request.
- Weather-resistant construction standard.
- Shatter resistant acrylic lens.
- Variety of Dial type and Sizes: 2-1/2", 3-1/2" & 4-1/2" (Uni-directional or Bi-directional)
- Available DP Ranges: Inches H<sub>2</sub>O, PSID, bar, and Kpa
- 1/4" FNPT & 1/2" FNPT Process Connections
- Multiple mounting options available
- Temperature Limits: -40°F(-40°C) to +200°F(+93°C)



Model 120 0-30 PSID  
With Maximum Follower Pointer



Model 120  
0-50 PSID  
4-1/2" Dial



Model 120  
0-50 PSID  
With Special 3 Color Dial

An optional maximum indication follower pointer provides automatic indication of maximum differential occurring during a time period or system cycle. Reversed pressure ports are optionally available to facilitate installation and readability depending on which side of a filter, etc., the instrument must be installed.

Model	Body Material	Accuracy	Min. ΔP Range	Max. ΔP Range	MWP PSIG (Bar)	Switch Options
120	Aluminum & 316L S.S.	±3/2/3%	0-5 PSID (0-0.35 bar)	0-110 PSID (0-7 bar)	ALM.= 3,000 (200) S.S. = 6,000 (400)	1 & 2 switch Hermetically Sealed

**Proof Pressure:** Two times rated working pressure at ambient temperature

**Standards:** Model 120 Gauge either conforms to and/or is designed to the requirements of the following standards:

ASME B1.20.1	NACE MR0175
ASME B40.100	NEMA Std. No. 250
CSA-C22.2 No. 14.25 and 30	SAE J514
EN-61010-1	UL Std. No. 50,508 and 1203

# “Piston Type” Differential Pressure Gauge Switch & Transmitter Options Models 120, 122, 123 & 124



The Model 120-124 Series DP gauges are available with one or two hermetically sealed reed switches or 4-20mA transmitter depending on model. (See chart below)

The switches are adjustable (see table for adjustment range) within a defined percentage of the full scale range of the gauge and are available in SPDT and SPST, normally open or normally closed configurations for various load power ratings. The switches can be set to activate or deactivate on rising or falling pressure.

The standard reed switch is enclosed in a weather-resistant plastic housing. Adjustment of the switch setting is made with an external screw adjustment.

The switch functionality will be different for gauges with bi-directional operation for positive and negative delta pressure. For example a SPDT switch with positive .P applied to the gauge, the red wire will be N.O. and the black will be N.C.. For negative .P the functionality will be reversed.

Location for a single SPDT (grommet or conduit) switch will be on the bottom of the gauge body for a normal port and on the top for a reverse port. Locations for a single SPST (grommet or conduit) N.O. or SPST N.C. switch will be on the bottom and top respectively for a normal port gauge. The locations will be reversed for a reverse port gauge.

A non-indicating (no dial) differential pressure switch is also available.

Hazardous Location switches are 3<sup>rd</sup> Party Certified Class I Div 2 or Class I Div 1 dependant on type of switch. Listings are for the entire design and not just the enclosure. Standard and weatherproof units are CE marked for conformance with the Low Voltage Directive to harmonized standard EN 61010-1.

Transmitters feature Microprocessor based, external zero interface, 8-28 Vdc loop powered, 2 wire interface. Standard output of 4-20mA with a max loop resistance of 1000 Ohms.

Model Type	•120, ^122,+123, +124 SPDT	•120,^122, •123, SPDT	•120, ^122,+123, +124 SPST NO	•120, •123,•124 SPST NC	•120, •123,•124 SPST NO/NC	121, 124 4-20mA
Power	3 W	60 W	60 W	60 W	60 W	4-20 mA Loop Power
Max Current	0.25 Amps	1.0 Amps	3.0 Amps	3.0 Amps	3.0 Amps	8-28 VDC Loop Powered 2-Wire interface
Max Voltage VAC/VDC	125	240	240	240	240	1000 Ohm max Loop resistance at 28 vdc
Setting Full Scale	•10-90%	•25-100%	•25-95%	•25-95%	•25-95%	20-100%
	^10-100%	^25-100%	^25-100%			
	+15-90%		+25-95%			
Hysteresis (Max / Norm)	10% / 5% (FS)	20% / 13% (FS)	15% / 8% (FS)	15% / 8% (FS)	15% / 8% (FS)	N/A
Repeatability	1% F.S.	1% F.S.	1% F.S.	1% F.S.	1% F.S.	1% F.S.
Leads 22 Awg	(3) 24"	(3) 24"	(2) 24"	(2) 24"	(2) 24"	N/A



# Mid-West<sup>®</sup> Instrument

## Standard Dial Ranges: Model 120, 122, 123, 124

Range Type			
PSID	Kpa	Bar	Dual Scale
0-5 PSID	0-35 Kpa	0-1.0 Bar	0-5 PSID & 0-0.35 Kg/Cm2
0-10 PSID	0-70 Kpa	0-1.6 Bar	0-5 PSID & 0-35 KPA
0-15 PSID	0-100 Kpa	0-2.0 Bar	0-10 PSID & 0-0.7 BAR
0-20 PSID	0-160 Kpa	0-2.5 Bar	0-10 PSID & 0-0.7 KG/CM2
0-25 PSID	0-250 kpa	0-4.0 Bar	0-10 PSID & 0-70 KPA
0-30 PSID	0-400 Kpa	0-6.0 Bar	0-100 PSID & 0-7 BAR
0-50 PSID	0-600 Kpa	0-7.0 Bar	0-100 PSID & 0-7 KG/CM2
0-60 PSID	0-700 Kpa		0-100 PSID & 0-700 KPA
0-75 PSID			0-15 PSID & 0-1 BAR
0-100 PSID			0-15 PSID & 0-1 KG/CM2
0-110 PSID			0-15 PSID & 0-100 KPA
**0-150 PSID			0-20 PSID & 0-1.4 BAR
**0-200 PSID			0-20 PSID & 0-140 KPA
**0-250 PSID			0-25 PSID & 0-1.75 BAR
**0-300 PSID			0-25 PSID & 0-1.75 KG/CM2
**0-400PSID			0-25 PSID & 0-175 KPA
			0-30 PSID & 0-2 BAR
<b>Bi-Directional</b>	<b>Bi-Directional</b>	<b>Bi-Directional</b>	0-30 PSID & 0-2 KG/CM2
5-0-5 PSID	40-0-40 Kpa	0.4-0-0.4 Bar	0-30 PSID & 0-200 KPA
10-0-10 PSID	60-0-60 Kpa	0.6-0-0.6 Bar	0-50 PSID & 0-3.5 BAR
15-0-15 PSID	100-0-100 Kpa	1-0-1 Bar	0-50 PSID & 0-3.5 KG/CM2
20-0-20 PSID	160-0-160 Kpa	1.6-0-1.6 Bar	0-50 PSID & 0-350 KPA
25-0-25 PSID	250-0-250 Kpa	2.5-0-2.5 Bar	0-75 PSID & 0-500 KPA
30-0-30 PSID	400-0-400 Kpa	4-0-4 Bar	
50-0-50 PSID	600-600 Kpa	6-0-6 Bar	
60-0-60 PSID			
100-0-100 PSID			

**Bi-Directional ranges available for Model 120 4-1/2" Dials only.**

The above mentioned ranges are some of the most popular requested today. Mid-West Instrument can provide special un-cataloged dial range requirements. As well as multiple scale dials, multiple color dials and special decals. Please consult factory for complete information.

Model	Min. ΔP Range	Max. ΔP Range
120	0-5 PSID (0-0.35 bar)	0-110 PSID (0-7 bar)
122	0-5 PSID (0-0.35 bar)	0-100 PSID (0-7 bar)
**123	0-150 PSID (0-10 bar)	0-400 PSID (0-27.0 bar)
**124	0-5 PSID (0-0.35 bar) 0-150 PSID (0-10 bar)	0-110 PSID (0-7 bar) 0-400 PSID (0-27.0 bar)

**Proof Pressure:** Two times rated working pressure at ambient temperature

**Temperature Limits:** -40°F (-40°C) to +200°F (+93°C) - These limits are based on the entire instrument being saturated to these temperatures. System (process) temperatures may exceed these limitations with proper installation. Contact our customer service representative for details.

**Standards:** Model 120 -124 Series gauges either conform to and/or are designed to the requirements of the following standards:

ASME B1.20.1	NACE MR0175
ASME B40.100	NEMA Std. No. 250
CSA-C22.2 No. 14.25 and 30	SAE J514
EN-61010-1	UL Std. No. 50,508 and 1203

## Standard Model Specifications: 120-AA-00-00

3000 PSIG Working Pressure, Aluminum Body & End Plugs, Stainless Steel Piston,  
Ceramic Magnet, Buna-N Seals, 1/4" FNPT Back Connections,  
2-1/2" round dial, Engineered Plastic Case with Shatter Resistant Acrylic Lens,  
Accuracy ±3/2/3% Full Scale (Ascending)

**Mid-West Instrument**  
1-800-648-5778

**Range 0-5 PSID to 0-110PSID (0.35 to 7.0 bar)**

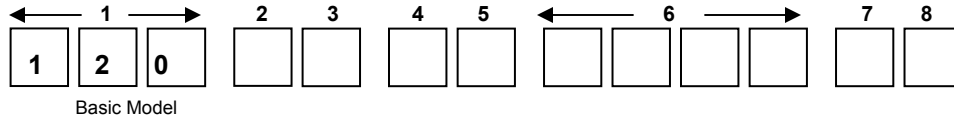

Range: \_\_\_\_\_



<b>2</b>	<b>Material</b>
<b>A</b>	Aluminum Body / Stainless Steel Piston
<b>S</b>	316 S.S Body / Stainless Steel Piston
<b>M</b>	Monel Body / Monel Piston
<b>N</b>	Aluminum Bronze Body / Aluminum Bronze Piston
<b>Z</b>	Special ( <i>Un-coded Options</i> )
<b>3</b>	<b>Dial Size &amp; Type</b>
<b>A</b>	2-1/2" Round Uni-Directional Dial w/Engineered Plastic Dial Case
<b>C</b>	4-1/2" Round Uni-Directional Dial w/Engineered Plastic Dial Case
<b>D</b>	4-1/2" Round Bi-Directional Dial w/Engineered Plastic Dial Case
<b>E</b>	3-1/2" Round Uni-Directional Dial w/Anodized Aluminum Housing Dial Case
<b>G</b>	4-1/2" Round Uni-Directional Dial w/Anodized Aluminum Housing Dial Case
<b>H</b>	4-1/2" Round Bi-Directional Dial w/Anodized Aluminum Housing Dial Case
<b>T</b>	Non-Indicating DP Switch Only
<b>Z</b>	Special ( <i>Un-coded Options</i> )
<b>4</b>	<b>Seal Materials</b>
<b>0</b>	Buna-N ( <i>Standard</i> )
<b>1</b>	Viton®-A Registered Trademark of Dupont
<b>2</b>	Neoprene
<b>4</b>	Teflon®-A Registered Trademark of Dupont
<b>5</b>	Ethylene Propylene
<b>6</b>	Perfluorelastomers
<b>9</b>	Special ( <i>Un-coded Options</i> )
<b>5</b>	<b>Process Connections</b>
<b>0</b>	1/4" FNPT Back Connections ( <i>Standard</i> ) ( <b>Not available on M &amp; N body materials</b> )
<b>2</b>	1/4" FNPT End Connections
<b>3</b>	1/4" FNPT Bottom Connections
<b>4</b>	1/2" FNPT End Connections
<b>6</b>	7/16"-20 Straight Thread "O" Ring Port ( <b>Back Connection</b> )
<b>9</b>	Special ( <i>Un-coded Options</i> )

Factory preset switches at no charge (Specify Setting)

## Standard Model Specifications – continued Model 120

6	Additional Options
O	None
A	Reversed High / Low Process Connections. <b>(Not available with Electrical options J &amp; K)</b>
C	Mounting Holes in Gauge Body for Field Mounting Electrical Configurations Options A & B
D	Mounting Holes in Gauge Body for Field Mounting Electrical Configurations Options L & M
E	Two (2) 1/4-20 Mounting Holes <b>(not available with C, D, E or F electrical switch options)</b>
F	Carbon Steel 2" Pipe Mounting Kit <b>(not available with C, D, E or F electrical switch options)</b>
G	Stainless Steel 2" Pipe Mounting Kit <b>(not available with C, D, E or F electrical switch options)</b>
K	1/2" FNPT S.S. Adapter <b>(not available with E or F switch option combined w/back connections)</b>
L	Liquid Fill (4-1/2" available with "G" option Aluminum Dial Case only) <b>(not available with shatterproof lens)</b>
M	Maximum Indicator Follower Pointer <b>(not available with Liquid fill option) (not available with shatterproof lens)</b>
N	NACE <b>(Available for Aluminum, Stainless Steel and Monel Gauge Bodies Only)</b>
Q	CRN (Canadian Registration Number) <b>Available on Aluminum or S.S. Body only</b>
S	Shatter Proof Glass Lens <b>(Available only with option "G" 4-1/2" Aluminum Dial Case) (not available with liquid fill)</b>
T	Oxygen Cleaning
U	Stainless Steel Tag with S.S. Wire
V	Stainless Steel Tag and S.S. Screw <b>(Contact Factory on Switch Options) Not on Gauge Body for Hazardous Locations</b>
W	Wall Mount Kit <b>(not available with back connections or with C, D, E or F switch options)</b>
Z	Special <b>(Un-coded Options)</b>
<b>NOTE: Not All Options Available in Combination with other Options</b>	
7	Electrical Configurations (CE marked, except E, F, J & K) (6)
A	One (1) Switch in standard enclosure with grommet Wire Seal
B	Two (2) Switch in standard enclosures with grommet Wire Seal
C	One (1) Switch in standard enclosure with 1/4" FNPT electrical connection NEMA 4X
D	Two (2) Switch in standard enclosures with 1/4" FNPT electrical connection NEMA 4X
E	One (1) Switch in general purpose enclosure, Division 2 Hazardous Locations <b>(1) (3) (4) (5)</b>
F	Two (2) Switches in general purpose enclosure, Division 2 Hazardous Locations <b>(1) (3) (4) (5)</b>
G	One (1) Switch & gauge in NEMA 4X plastic enclosure <b>(Not available with end connections)</b>
H	Two (2) Switches & gauge in NEMA 4X plastic enclosure <b>(Not available with end connections)</b>
J	One (1) Switch in explosion proof enclosure w/glass window cover, Div. 1 Hazardous Locations <b>(2) (3) (4) (5)</b>
K	Two (2) Switches in explosion proof enclosure w/glass window cover, Div.1 Hazardous Locations <b>(2) (3) (4) (5)</b>
L	One (1) Switch in standard enclosure with plug-in connector (DIN 43650/IP65-PG11)
M	Two (2) Switch in standard enclosures with plug-in connector (DIN 43650/IP65-PG11)
Z	Special <b>(Un-coded Options)</b>
(1) Complete assembly 3rd Party Certified Class I, Div.2, Groups A, B, C, & D; Class II, Div.2, Groups F and G.	
(2) Complete assembly 3rd Party Certified Class I, Div.1, Groups C & D; Class II, Div. 1, Groups E, F, & G.	
(3) 5000 PSIG SWP for Stainless Steel: 3000 PSIG SWP for Aluminum	
(4) Not available in M and N material options	
(5) 1/2" FNPT conduit connection	
(6) Contact factory for Bi-directional scales with switches	
8	Electrical Specifications (For Resistive Loads)
A	SPDT 3W, 0.25 Amp, 125 VAC/VDC (standard) (Switch adjustable range of 10-90%)
E	SPST 60W, 3.0 Amp, 240 VAC/VDC (Normally Open) (Switch adjustable range of 25-95%)
F	SPST 60W, 3.0 Amp, 240 VAC/VDC (Normally Closed) (Switch adjustable range of 25-95%)
G	SPST 60W, 3.0 Amp, 240 VAC/VDC (1) Normally Open, (1) Normally Closed (Switch adjustable range of 25-95%)
H	SPDT 60W, 1.0 Amp, 240 VAC/VDC (Switch adjustable range of 25-100%)
Z	Special <b>(Un-coded Options)</b>

If you are in need of additional information please visit our web site at [www.midwestinstrument.com](http://www.midwestinstrument.com) or contact us toll free at **1-800-648-5778** and one of our knowledgeable sales coordinators will be happy to assist you...





# Mid-West<sup>®</sup> Instrument

## “Piston Type”

### Differential Pressure Gauge or Switch

## Model 120



### FOR SEA WATER APPLICATIONS

Ideally suited for use on Sea Water or salt Water applications.

Model 120 Shown  
With 2-1/2" Dial & Switch



**Features:**

- Simple, rugged, compact design.
- Working pressure 5,000 PSIG (340 bar)
- Over-range protection to maximum pressure.
- Over range protection to full rated working pressure.
- Body Materials: Aluminum/Bronze, or Monel
- 1/4" FNPT FNPT End Connection (std)
- Weather-resistant construction standard.
- Shatter resistant acrylic lens.
- Variety of Dial type and Sizes: 2-1/2", 3-1/2" & 4-1/2"
- DP Ranges available in: Inches PSID, Bar, and Kpa
- Temperature Limits: -40°F(-40°C) to +200°F(+93°C)

Due to precision sizing of piston and body bore, leakage across piston will not exceed 15 SCFH air at 100 PSID at ambient temperature.



Model 120 shown  
with Customer colored Dial



Model 120 Shown  
With 4-1/2" Dial

An optional maximum indication follower pointer provides automatic indication of maximum differential occurring during a time period or system cycle. Reversed pressure ports are optionally available to facilitate installation and readability depending on which side of a filter, etc., the instrument must be installed.

Model	Accuracy	Available $\Delta P$ Range	Max. Line Pressure PSIG	Optional Switches
120	$\pm 5\%$	0-5 PSID, 0-10 PSID 0-15 PSID, 0-20 PSID 0-25 PSID, 0-30 PSID 0-50 PSID, 0-100 PSID	5,000	1 & 2 switch Hermetically Sealed

# “Piston Type” Differential Pressure Gauge Switch Options Model 120



1 & 2 Switch  
Examples shown



The Model 120 Series DP gauge is available with one or two hermetically sealed reed switches. (See chart below)

The switches are adjustable (see table for adjustment range) within a defined percentage of the full scale range of the gauge and are available in SPDT and SPST, normally open or normally closed configurations for various load power ratings. The switches can be set to activate or deactivate on rising or falling pressure.

The standard reed switch is enclosed in a weather-resistant plastic housing. Adjustment of the switch setting is made with an external screw adjustment.

The switch functionality will be different for gauges with bi-directional operation for positive and negative delta pressure. For example a SPDT switch with positive  $\Delta P$  applied to the gauge, the red wire will be N.O. and the black will be N.C.. For negative  $\Delta P$  the functionality will be reversed.

Location for a single SPDT (grommet or conduit) switch will be on the bottom of the gauge body for a normal port and on the top for a reverse port. Locations for a single SPST (grommet or conduit) N.O. or SPST N.C. switch will be on the bottom and top respectively for a normal port gauge. The locations will be reversed for a reverse port gauge. A non-indicating (no dial) differential pressure switch is also available.

Model Type	120 SPDT	120 SPDT	120 SPST NO	120 SPST NC	120 SPST NO/NC
Power	3 W	60 W	60 W	60 W	60 W
Max Current	0.25 Amps	1.0 Amps	3.0 Amps	3.0 Amps	3.0 Amps
Max Voltage VAC/VDC	125	240	240	240	240
Setting Full Scale	10-90%	25-100%	25-95%	25-95%	25-95%
Hysteresis (Max / Norm)	10% / 5% (FS)	20% / 13% (FS)	15% / 8% (FS)	15% / 8% (FS)	15% / 8% (FS)
Repeatability	1% F.S.	1% F.S.	1% F.S.	1% F.S.	1% F.S.
Leads 22 Awg	(3) 24"	(3) 24"	(2) 24"	(2) 24"	(2) 24"

### Standard Model Specifications: 120-NA-02-00

5000 PSIG Working Pressure, Aluminum Bronze Body & Piston, Monel Spring, Ceramic Magnet, Buna-N Seals, 1/4" FNPT End Connections, 2-1/2" round dial, Engineered Plastic Case with Shatter Resistant Acrylic Lens, Accuracy ±5% Full Scale (Ascending)

Ranges: 0-10 PSID, 0-15 PSID, 0-10 PSID, 0-25 PSID and 0-30 PSID

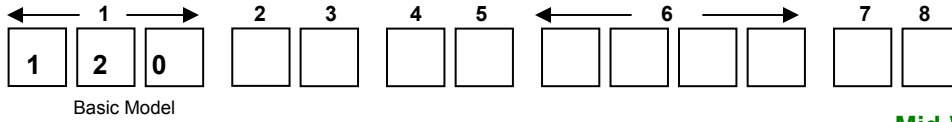

Range: \_\_\_\_\_

Mid-West Instrument  
1-800-648-5778



<b>2</b>	<b>Material</b>
<b>M</b>	Monel Body / Monel Piston
<b>N</b>	Aluminum Bronze Body / Aluminum Bronze Piston
<b>Z</b>	Special ( <i>Un-coded Options</i> )
<b>3</b>	<b>Dial Size &amp; Type</b>
<b>A</b>	2-1/2" Round Uni-Directional Dial w/Engineered Plastic Dial Case
<b>C</b>	4-1/2" Round Uni-Directional Dial w/Engineered Plastic Dial Case
<b>E</b>	3-1/2" Round Uni-Directional Dial w/Anodized Aluminum Housing Dial Case
<b>G</b>	4-1/2" Round Uni-Directional Dial w/Anodized Aluminum Housing Dial Case
<b>T</b>	Non-Indicating DP Switch Only
<b>Z</b>	Special ( <i>Un-coded Options</i> )
<b>4</b>	<b>Seal Materials</b>
<b>0</b>	Buna-N (Standard)
<b>1</b>	Viton®-A Registered Trademark of Dupont
<b>2</b>	Neoprene
<b>4</b>	Teflon®-A Registered Trademark of Dupont
<b>5</b>	Ethylene Propylene
<b>9</b>	Special ( <i>Un-coded Options</i> )
<b>5</b>	<b>Process Connections</b>
<b>2</b>	1/4" FNPT End Connections
<b>9</b>	Special ( <i>Un-coded Options</i> )

## Standard Model Specifications – continued Model 120

6	Additional Options
<b>O</b>	None
<b>A</b>	Reversed High / Low Process Connections.
<b>E</b>	Two (2) 1/4-20 Mounting Holes (not available with C or D electrical switch options)
<b>F</b>	Carbon Steel 2" Pipe Mounting Kit (not available with C or D electrical switch options)
<b>G</b>	Stainless Steel 2" Pipe Mounting Kit (not available with C or D electrical switch options)
<b>L</b>	Liquid Fill (4-1/2" available with "G" option Aluminum Dial Case only) (not available with shatterproof lens)
<b>M</b>	Maximum Indicator Follower Pointer (not available with Liquid fill option) (not available with shatterproof lens)
<b>S</b>	Shatter Proof Glass Lens (Available only with option "G" 4-1/2" Aluminum Dial Case) (not available with liquid fill)
<b>T</b>	Oxygen Cleaning
<b>U</b>	Stainless Steel Tag with S.S. Wire
<b>V</b>	Stainless Steel Tag and S.S. Screw (Contact Factory on Switch Options) Not on Gauge Body for Hazardous Locations
<b>W</b>	Wall Mount Kit (not available with C or D switch options)
<b>Z</b>	Special ( <b>Un-coded Options</b> )
<b>NOTE: Not All Options Available in Combination with other Options</b>	
7	Electrical Configurations (CE marked) (6)
<b>A</b>	One (1) Switch in standard enclosure with grommet Wire Seal
<b>B</b>	Two (2) Switch in standard enclosures with grommet Wire Seal
<b>C</b>	One (1) Switch in standard enclosure with 1/4" FNPT electrical connection NEMA 4X
<b>D</b>	Two (2) Switch in standard enclosures with 1/4" FNPT electrical connection NEMA 4X
<b>L</b>	One (1) Switch in standard enclosure with plug-in connector (DIN 43650/IP65-PG11)
<b>M</b>	Two (2) Switch in standard enclosures with plug-in connector (DIN 43650/IP65-PG11)
<b>Z</b>	Special ( <b>Un-coded Options</b> )
(6) Contact factory for Bi-directional scales with switches	
8	Electrical Specifications (For Resistive Loads)
<b>A</b>	SPDT 3W, 0.25 Amp, 125 VAC/VDC (standard) (Switch adjustable range of 10-90%)
<b>E</b>	SPST 60W, 3.0 Amp, 240 VAC/VDC (Normally Open) (Switch adjustable range of 25-95%)
<b>F</b>	SPST 60W, 3.0 Amp, 240 VAC/VDC (Normally Closed) (Switch adjustable range of 25-95%)
<b>G</b>	SPST 60W, 3.0 Amp, 240 VAC/VDC (1) Normally Open, (1) Normally Closed (Switch adjustable range of 25-95%)
<b>H</b>	SPDT 60W, 1.0 Amp, 240 VAC/VDC (Switch adjustable range of 25-100%)
<b>Z</b>	Special ( <b>Un-coded Options</b> )

Factory preset switches at no charge (Specify Setting)

**MID-WEST INSTRUMENT** has been serving a variety of industries (Power, Chemical, Petro-Chemical, HVAC, Water Filtration etc...) for over 50 years. Over 700,000 piston type units have been produced bearing the Mid-West name or private branded for our OEM customers!

Mid-West understands that in today's demanding environment, flexibility, quick response time and the ability to ship product in 2 weeks or less is essential to our customers. Standard configurations can be customized and modified to suit our customer's needs for ease of installation or retrofit.

If you are in need of additional information please visit our web site at [www.midwestinstrument.com](http://www.midwestinstrument.com) or contact us toll free at **1-800-648-5778** and one of our knowledgeable sales coordinators will be happy to assist you...

# Mid-West<sup>®</sup> Instrument

## “Piston Type” Model 121 Differential Pressure Switch & Transmitter

A low cost differential pressure indicating switch or transmitter for use in measuring the pressure drop across filters, strainers, separators, valves, pumps, chillers etc., and for local flow indication and control.

- ½ NPT conduit connection with heavy duty Switch or Transmitter cover and terminal strip
- Choice of 1 or 2 magnetically actuated hermetically sealed reed switches to provide high and low limit alarm or control or 4-20mA transmitter.
- Transmitter accuracy ± 2% full scale (from 20% to 100% of scale, ascending)
- Body materials: Aluminum or 316L Stainless Steel with 316 stainless steel internals.
- Weather-resistant construction standard.
- Working pressure up to 6,000 PSIG (400 bar)
- Over-range protection to maximum pressure.
- Shatter resistant acrylic lens.
- Variety of Dial type and Sizes: 2-1/2”, 3-1/2” & 4-1/2”
- Available DP Ranges: Inches H2O, PSID, bar, and Kpa
- Temperature Limits:  
-40°F (-40°C) to +200°F (+93°C) (Switch Options)  
-20° F to + 150° F (Transmitter Option)

**Transmitter now  
CSA Listed for  
Division 2 Hazardous  
Location Service**



Model 121 0-75 PSID  
2-1/2” Dial. Shown with  
End Connections & Transmitter



Model 121 Switch  
¼” FNPT back  
connections



Model 121  
0-50 PSID 4-1/2” Dial  
& Transmitter



Model	Body Material	Gauge Accuracy	Min. ΔP Range	Max. ΔP Range	MWP PSIG (Bar)	Switch Options
121	Aluminum & 316L S.S.	±3/2/3%	0-5 PSID (0-0.35 bar)	0-100 PSID (0-7 bar)	ALM. = 3,000 (200) S.S. = 6,000 (400)	1 or 2 switches or 4-20mA Transmitter

### Model 121 Indicating Switch(es) or 4-20mA Transmitter SPECIFICATIONS

#### TRANSMITTER

##### Features:

Microprocessor based, external zero interface:  
8-28 Vdc loop powered, 2 wire interface

##### Electrical:

Accuracy ±2% (from 20% to 100% of scale, ascending)  
Supply Voltage 8-28 Vdc  
Output 4-20mA  
Max Loop Resistance 1000 Ohms

##### Interface:

4 position terminal strip for 16-22 Awg wire  
Pin 1 – return, Pin 2 = zero, Pin 3 = 8-28 Vdc, Pin 4-chassis  
1/2” NPT conduit connection

**Environmental:** Weatherproof

**Rating:** (NEMA 4X, IP65)

#### SWITCHES

##### Features:

1 or 2 hermetically sealed reed switches

##### Electrical:

0-3W, 25 Amp  
125 VAC (Adjustable 15-95% F.S.)  
60W, 3.0 Amp  
240 VAC (Adjustable 20-95% F.S.)

##### Interface:

7 position terminal strip for 16-22 Awg wire  
1/2” NPT conduit connection

**Environmental:** Weatherproof

**Rating:** (NEMA 4X, IP65)

# “Piston Type” Differential Pressure Switch & Transmitter Options Model 121



Open back view  
Model 121 reed switch  
with terminal strip



Model 121 Transmitter show  
with NEMA 4X plastic cover



Open view Model 121 Transmitter  
4-20 mA terminal strip  
w/ 1/4" FNPT end connections

Piston-Type Differential Pressure Gauges are available with one or two hermetically sealed reed switches. The switches are adjustable within a defined percentage of the full scale range of the gauge and are available in SPDT and SPST, normally open or normally closed configurations for various load/power ratings. The switches can be set to activate or deactivate on rising or falling pressure. Switches are "CE" marked per the EU low voltage directive. Models 121 can be configured for use in Hazardous Locations.

Piston Type DP Gauge:  $\pm 2\%$  Full Scale Accuracy. They are primarily designed for liquid applications. They exhibit a slight amount of bypass as the fluid crosses from the high to the low pressure port. Because gas molecules are smaller, the crossover is often deemed too great for the application. Due to precision sizing of piston and body bore, leakage across the piston will not exceed 15 SCFH air at 100 PSID at ambient conditions.

Available Electrical Configurations
One (1) Reed switch in NEMA 4X/IP65 Plastic enclosure with terminal strip (1/2" FNPT Conduit Connection)
Two (2) Reed switches in NEMA 4X/IP65 Plastic enclosure with terminal strip (1/2" FNPT Conduit Connection)
One (1) Switch in general purpose enclosure, Division 2 Hazardous Locations (1) (2)
Two (2) Switches in general purpose enclosure, Division 2 Hazardous Locations (1) (2)
4-20 mA Transmitter in NEMA 4X/IP65 Plastic enclosure with terminal strip (1/2" FNPT Conduit Connection) (3)
4-20 mA Transmitter in NEMA 4X/IP65 Plastic enclosure. Division 2 Hazardous Locations with terminal strip (1/2" FNPT Conduit Connection) (1) (2) (3)
(1) Complete assembly 3rd Party Certified Class I, Div.2, Groups A, B, C, & D; Class II, Div.2, Groups F and G.
(2) 5000 PSIG SWP for Stainless Steel: 3000 PSIG SWP for Aluminum
(3) Contact factory for flow applications with transmitter configuration
Available Electrical Specifications (For Resistive Loads)
SPDT 3W, 0.25 Amp, 125 VAC/VDC (standard) (Switch adjustable range of 15-95%)
SPST 60W, 3.0 Amp, 240 VAC/VDC (Normally Open) (Switch adjustable range of 20-95%)
SPST 60W, 3.0 Amp, 240 VAC/VDC (Normally Closed) (Switch adjustable range of 20-95%)
SPST 60W, 3.0 Amp, 240 VAC/VDC (1) Normally Open, (1) Normally Closed (Switch adjustable range of 20-95%)
4-20 mA Transmitter (8-28 VDC Loop Power) ( $\pm 2\%$ accuracy from 20% to 100% of scale. Ascending)

**Proof Pressure:** Two times rated working pressure at ambient temperature.

**Temperature Limits:**

**Switch Options:** -40°F to + 200°F

**Transmitter Options:** -20° F TO + 150° F

These limits are based on the entire instrument being saturated to these temperatures. System (process) temperatures may exceed these limitations with proper installation. Contact our customer service representative for details.

**Standards:** Model 121 Gauge either conforms to and/or is designed to the requirements of the following standards:

- |                            |                             |
|----------------------------|-----------------------------|
| ASME B1.20.1               | NACE MR0175                 |
| ASME B40.100               | NEMA Std. No. 250           |
| CSA-C22.2 No. 14.25 and 30 | SAE J514                    |
| EN-61010-1                 | UL Std. No. 50,508 and 1203 |

# Mid-West<sup>®</sup> Instrument

## Standard Dial Ranges: **Model 121**

Range Type		
PSID	Kpa	Bar
0-5 PSID	0-100 Kpa	0-1.0 Bar
0-10 PSID	0-160 Kpa	0-1.6 Bar
0-15 PSID	0-250 kpa	0-2.0 Bar
0-20 PSID	0-400 Kpa	0-2.5 Bar
0-25 PSID	0-600 Kpa	0-4.0 Bar
0-30 PSID	0-700 Kpa	0-6.0 Bar
0-50 PSID		0-7.0 Bar
0-60 PSID		
0-75 PSID		
0-100 PSID		

The above mentioned ranges are some of the most popular requested today. Mid-West Instrument can provide special un-cataloged dial range requirements. As well as multiple scale dials, multiple color dials and special decals. Please consult factory for complete information.

Model	Min. ΔP Range	Max. ΔP Range
121	0-5 PSID (0-0.35 bar)	0-100 PSID (0-7 bar)

**Proof Pressure:** Two times rated working pressure at ambient temperature.

**Temperature Limits:**

**Switch Options:** -40°F to + 200°F

**Transmitter Options:** -20° F TO + 150° F

These limits are based on the entire instrument being saturated to these temperatures. System (process) temperatures may exceed these limitations with proper installation. Contact our customer service representative for details.

**Standards:** Model 121 Gauge either conforms to and/or is designed to the requirements of the following standards:

- |                            |                             |
|----------------------------|-----------------------------|
| ASME B1.20.1               | NACE MR0175                 |
| ASME B40.100               | NEMA Std. No. 250           |
| CSA-C22.2 No. 14.25 and 30 | SAE J514                    |
| EN-61010-1                 | UL Std. No. 50,508 and 1203 |

### Standard Model Specifications: 121-AA-00-O(TT)

3000 PSIG Working Pressure, Aluminum Body, Adjusting Screws & End Plugs, Stainless Steel Piston, Ceramic Magnet, Buna-N Seals, 1/4" FNPT Back Connections, 2-1/2" round dial, Engineered Plastic Case with Shatter Resistant Acrylic Lens, 4-20mA, 8-28 VDC Loop powered Transmitter in NEMA 4X/IP65 Plastic enclosure with terminal strip, & 1/2" FNPT Conduit Connection, Accuracy ±3/2/3% Full Scale (Ascending)

**Mid-West Instrument**  
1-800-648-5778

**Range 0-5 PSID to 0-100PSID (0-.35 bar to 0-7.0 bar)**

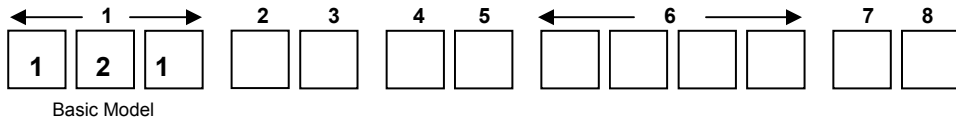

Range: \_\_\_\_\_



2	Material
<b>A</b>	Aluminum Body / Stainless Steel Piston
<b>S</b>	316 S.S Body / Stainless Steel Piston
<b>Z</b>	Special ( <i>Un-coded Options</i> )
3	Dial Size & Type
<b>A</b>	2-1/2" Round Uni-Directional Dial w/Engineered Plastic Dial Case
<b>C</b>	4-1/2" Round Uni-Directional Dial w/Engineered Plastic Dial Case
<b>E</b>	3-1/2" Round Uni-Directional Dial w/Anodized Aluminum Housing Dial Case
<b>G</b>	4-1/2" Round Uni-Directional Dial w/Anodized Aluminum Housing Dial Case
<b>T</b>	Non-Indicating DP Switch Only
<b>Z</b>	Special ( <i>Un-coded Options</i> )
4	Seal Materials
<b>0</b>	Buna-N ( <b>Standard</b> )
<b>1</b>	Viton®-A Registered Trademark of Dupont
<b>2</b>	Neoprene
<b>4</b>	Teflon®-A Registered Trademark of Dupont
<b>5</b>	Ethylene Propylene
<b>6</b>	Perfluorelastomers
<b>9</b>	Special ( <i>Un-coded Options</i> )
5	Process Connections
<b>0</b>	1/4" FNPT Back Connections ( <b>Standard</b> )
<b>2</b>	1/4" FNPT End Connections
<b>3</b>	1/4" FNPT Bottom Connections
<b>4</b>	1/2" FNPT End Connections
<b>6</b>	7/16"-20 Straight Thread "O" Ring Port ( <b>Back Connection</b> )
<b>9</b>	Special ( <i>Un-coded Options</i> )

Factory preset switches at no charge (Specify Setting)



## Standard Model Specifications – continued Model 121



6	Additional Options
O	None
F	Carbon Steel 2" Pipe Mounting Kit
G	Stainless Steel 2" Pipe Mounting Kit
K	1/2" FNPT Stainless Steel Adapter
L	Liquid Fill (4-1/2" available with "G" option Aluminum Dial Case only) (not available with shatterproof lens)
M	Maximum Indicator Follower Pointer (Not available with Liquid fill option) (not available with shatterproof lens)
N	NACE
Q	CRN (Canadian Registration Number) (2)
S	Shatter Proof Glass Lens (Available only with 4-1/2" Aluminum Dial Case) (not available with liquid fill)
T	Oxygen Cleaning
U	Stainless Steel Tag with S.S. Wire
W	Wall Mount Kit (Not available with back connections)
Z	Special ( <b>Un-coded Options</b> )
7	Electrical Configurations
A	One (1) Reed switch in NEMA 4X/IP65 Plastic enclosure with terminal strip (1/2" FNPT Conduit Connection)
B	Two (2) Reed switches in NEMA 4X/IP65 Plastic enclosure with terminal strip (1/2" FNPT Conduit Connection)
E	One (1) Switch in general purpose enclosure, Division 2 Hazardous Locations (1) (2)
F	Two (2) Switches in general purpose enclosure, Division 2 Hazardous Locations (1) (2)
T	4-20 mA Transmitter in NEMA 4X/IP65 Plastic enclosure with terminal strip (1/2" FNPT Conduit Connection) (3)
W	4-20 mA Transmitter in NEMA 4X/IP65 Plastic enclosure. Division 2 Hazardous Locations with terminal strip (1/2" FNPT Conduit Connection) (1) (2) (3)
Z	Special ( <b>Un-coded Options</b> )
	(1) Complete assembly 3rd Party Certified Class I, Div.2, Groups A, B, C, & D; Class II, Div.2, Groups F and G.
	(2) 5000 PSIG SWP for Stainless Steel: 3000 PSIG SWP for Aluminum
	(3) Contact factory for flow applications with transmitter configuration
8	Electrical Specifications (For Resistive Loads)
A	SPDT 3W, 0.25 Amp, 125 VAC/VDC (standard) (Switch adjustable range of 15-95%)
E	SPST 60W, 3.0 Amp, 240 VAC/VDC (Normally Open) (Switch adjustable range of 20-95%)
F	SPST 60W, 3.0 Amp, 240 VAC/VDC (Normally Closed) (Switch adjustable range of 20-95%)
G	SPST 60W, 3.0 Amp, 240 VAC/VDC (1) Normally Open, (1) Normally Closed (Switch adjustable range of 20-95%)
T	4-20 mA Transmitter (8-28 VDC Loop Power) ( ±2% accuracy from 20% to 100% of scale. Ascending)
Z	Special ( <b>Un-coded Options</b> )

MID-WEST INSTRUMENT has been serving a variety of industries (Power, Chemical, Petro-Chemical, HVAC, Water Filtration etc...) for over 50 years. Over 700,000 piston type units have been produced bearing the Mid-West name or private branded for our OEM customers!

Mid-West understands that in today's demanding environment, flexibility, quick response time and the ability to ship product in 2 weeks or less is essential to our customers. Standard configurations can be customized and modified to suit our customer's needs for ease of installation or retrofit.

If you are in need of additional information please visit our web site at [www.midwestinstrument.com](http://www.midwestinstrument.com) or contact us toll free at **1-800-648-5778** and one of our knowledgeable sales coordinators will be happy to assist you...



# Mid-West<sup>®</sup> Instrument

## “Piston Type”

### Differential Pressure Gauges Switches & Transmitters

## Model 122



A low cost differential pressure gauge for use in measuring the pressure drop across filters, strainers, separators, valves, pumps, chillers, etc., and for local flow indication and control.



Model 122  
With Special  
3 color dial

- Simple, rugged, compact design.
- Working pressure up to 3,000 PSIG (200 bar)
- Over-range protection to maximum pressure.
- Body material: Aluminum with 316 stainless steel internals.
- Weather-resistant construction standard.
- Shatter resistant acrylic lens.
- Variety of Dial type and Sizes: 2-1/2", 3-1/2" & 4-1/2"
- Available DP Ranges: Inches H<sub>2</sub>O, PSID, bar, and Kpa
- 1/4" FNPT End Process Connections
- Panel Mountable, Wall mount available as option
- Temperature Limits: -40°F(-40°C) to +200°F(+93°C)

Due to precision sizing of piston and body bore, leakage across piston will not exceed 15 SCFH air at 100 PSID at ambient temperature.



Model 122 0-30 PSID  
2-1/2" Dial w/Maximum  
Follower Pointer



Model 122  
0-50 PSID  
4-1/2" Dial



Model 122  
0-15 PSID

An optional maximum indication follower pointer provides automatic indication of maximum differential occurring during a time period or system cycle. Reversed pressure ports are optionally available to facilitate installation and readability depending on which side of a filter, etc., the instrument must be installed.

Model	Body Material	Accuracy	Min. ΔP Range	Max. ΔP Range	MWP PSIG (Bar)	Switch Options
122	Aluminum	±5%	0-5 PSID (0-0.35 bar)	0-110 PSID (0-7 bar)	3,000 (200)	1 & 2 switch Hermetically Sealed

**Proof Pressure:** Two times rated working pressure at ambient temperature

**Standards:** Model 122 gauge either conforms to and/or is designed to the requirements of the following standards:

ASME B1.20.1	NACE MR0175
ASME B40.100	NEMA Std. No. 250
CSA-C22.2 No. 14.25 and 30	SAE J514
EN-61010-1	UL Std. No. 50,508 and 1203

# “Piston Type” Differential Pressure Gauge Switch Option Model 122



Model 122 Gauge with switches have one or two Single Pole Single Throw (SPST) or Single Pole Double Throw (SPDT) reed switches with the resistive ratings specified in the table below.

A provision to connect a protective conductor terminal is provided on the Low port end of the gauge body. A 6-32 screw, 18 Awg, green/yellow wire, and a #6 terminal is provided.

**Note:** Switches can be set below the defined minimum set point how ever the switch may not remain activated at maximum PSID. If the unit is set below the defined minimum set point, the customer should verify that the switch remains activated from the set point to over range of the gauge.

Provide standard protection techniques for the switch contacts for capacitive and inductive loads. Use current limiting techniques near the switch to protect the contacts due to high inrush (i.e.; in line resistor or inductor) for long cable interfaces. Provide clamping devices at or near inductive loads (i.e.; relay).

Maximum wire length between the 3W switch and its load should not exceed 70 – 100 feet or 120 VAC applications. Contact the factory for assistance regarding this condition.

**WARNING:**

Electrical connections should be performed by qualified personnel and meet representative national electrical code.

**WARNING:**

Failure to connect to the protective conductor terminal may result in a shock hazard.



**Temperature Limits:**

-40°F (-40°C) to +200°F (+93°C)  
These limits are based on the entire instrument being saturated to these temperatures. System (process) temperatures may exceed these limitations

**REED SWITCH RATINGS (Resistive Load)**



Type	SPDT	SPST NO	SPDT
Option	<b>A</b>	<b>E</b>	<b>H</b>
Power	3 W	60 W	60 W
Max Current	0.25 Amps	3.0 Amps	1.0 Amps
Max Voltage VAC/VDC	125	240	240
Setting Full Scale	10-100%	25-100%	25-100%
Hysteresis (Max / Norm)	10% / 5% (FS)	15% / 8% (FS)	25% / 13% (FS)
Repeatability	1% F.S.	1% F.S.	1% F.S.
Leads 22 Awg	(3) 24"	(2) 24"	(3) 24"

# Mid-West<sup>®</sup> Instrument

## Standard Dial Ranges: Model 120, 122, 123, 124

Range Type			
PSID	Kpa	Bar	Dual Scale
0-5 PSID	0-35 Kpa	0-1.0 Bar	0-5 PSID & 0-0.35 Kg/Cm2
0-10 PSID	0-70 Kpa	0-1.6 Bar	0-5 PSID & 0-35 KPA
0-15 PSID	0-100 Kpa	0-2.0 Bar	0-10 PSID & 0-0.7 BAR
0-20 PSID	0-160 Kpa	0-2.5 Bar	0-10 PSID & 0-0.7 KG/CM2
0-25 PSID	0-250 kpa	0-4.0 Bar	0-10 PSID & 0-70 KPA
0-30 PSID	0-400 Kpa	0-6.0 Bar	0-100 PSID & 0-7 BAR
0-50 PSID	0-600 Kpa	0-7.0 Bar	0-100 PSID & 0-7 KG/CM2
0-60 PSID	0-700 Kpa		0-100 PSID & 0-700 KPA
0-75 PSID			0-15 PSID & 0-1 BAR
0-100 PSID			0-15 PSID & 0-1 KG/CM2
0-110 PSID			0-15 PSID & 0-100 KPA
**0-150 PSID			0-20 PSID & 0-1.4 BAR
**0-200 PSID			0-20 PSID & 0-140 KPA
**0-250 PSID			0-25 PSID & 0-1.75 BAR
**0-300 PSID			0-25 PSID & 0-1.75 KG/CM2
**0-400PSID			0-25 PSID & 0-175 KPA
			0-30 PSID & 0-2 BAR
<b>Bi-Directional</b>	<b>Bi-Directional</b>	<b>Bi-Directional</b>	0-30 PSID & 0-2 KG/CM2
5-0-5 PSID	40-0-40 Kpa	0.4-0-0.4 Bar	0-30 PSID & 0-200 KPA
10-0-10 PSID	60-0-60 Kpa	0.6-0-0.6 Bar	0-50 PSID & 0-3.5 BAR
15-0-15 PSID	100-0-100 Kpa	1-0-1 Bar	0-50 PSID & 0-3.5 KG/CM2
20-0-20 PSID	160-0-160 Kpa	1.6-0-1.6 Bar	0-50 PSID & 0-350 KPA
25-0-25 PSID	250-0-250 Kpa	2.5-0-2.5 Bar	0-75 PSID & 0-500 KPA
30-0-30 PSID	400-0-400 Kpa	4-0-4 Bar	
50-0-50 PSID	600-600 Kpa	6-0-6 Bar	
60-0-60 PSID			
100-0-100 PSID			

**Bi-Directional ranges available for Model 120 4-1/2" Dials only.**

The above mentioned ranges are some of the most popular requested today. Mid-West Instrument can provide special un-cataloged dial range requirements. As well as multiple scale dials, multiple color dials and special decals. Please consult factory for complete information.

Model	Min. ΔP Range	Max. ΔP Range
120	0-5 PSID (0-0.35 bar)	0-110 PSID (0-7 bar)
122	0-5 PSID (0-0.35 bar)	0-100 PSID (0-7 bar)
**123	0-150 PSID (0-10 bar)	0-400 PSID (0-27.0 bar)
**124	0-5 PSID (0-0.35 bar) 0-150 PSID (0-10 bar)	0-110 PSID (0-7 bar) 0-400 PSID (0-27.0 bar)

**Proof Pressure:** Two times rated working pressure at ambient temperature

**Temperature Limits:** -40°F(-40°C) to +200°F(+93°C)

Transmitter Option: -20°F(-28°C) to +150°F(+65°C)

These limits are based on the entire instrument being saturated to these temperatures. System (process) temperatures may exceed these limitations with proper installation. Contact our customer service representative for details.

**Standards:** Model 120 -124 Series gauges either conform to and/or are designed to the requirements of the following standards:

ASME B1.20.1

ASME B40.100

CSA-C22.2 No. 14.25 and 30

EN-61010-1

NACE MR0175

NEMA Std. No. 250

SAE J514

UL Std. No. 50,508 and 1203

## Standard Model Specification: 122-AA-02-00

3000 PSIG Working Pressure, Aluminum Body, Stainless Steel Piston, Ceramic Magnet,  
Buna-N Seals, 1/4" FNPT End Connections, 2-1/2" round dial,  
Engineered Plastic Case with Shatter Resistant Acrylic Lens,  
Accuracy ±5% Full Scale (Ascending)

**Mid-West Instrument**

**1-800-648-5778**

**Range: 0-5 PSID to 0-100 PSID (0-.35 bar to 0-7.0 bar)**

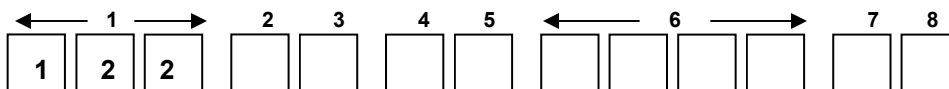

Basic Model

Range: \_\_\_\_\_



<b>2</b>	<b>Material</b>
<b>A</b>	Aluminum Body / Stainless Steel Piston
<b>Z</b>	Special ( <i>Un-coded Options</i> )
<b>3</b>	<b>Dial Size &amp; Type</b>
<b>A</b>	2-1/2" Round Uni-Directional Dial w/Engineered Plastic Dial Case
<b>C</b>	4-1/2" Round Uni-Directional Dial w/Engineered Plastic Dial Case
<b>E</b>	3-1/2" Round Uni-Directional Dial w/Anodized Aluminum Housing Dial Case
<b>G</b>	4-1/2" Round Uni-Directional Dial w/Anodized Aluminum Housing Dial Case
<b>T</b>	Non-Indicating DP Switch Only
<b>Z</b>	Special ( <i>Un-coded Options</i> )
<b>4</b>	<b>Seal Materials</b>
<b>0</b>	Buna-N (Standard)
<b>1</b>	Viton®-A Registered Trademark of Dupont
<b>2</b>	Neoprene
<b>4</b>	Teflon®-A Registered Trademark of Dupont
<b>5</b>	Ethylene Propylene
<b>9</b>	Special ( <i>Un-coded Options</i> )
<b>5</b>	<b>Process Connections</b>
<b>2</b>	1/4" FNPT End Connections (Standard)
<b>9</b>	Special ( <i>Un-coded Options</i> )

Factory preset switches at no charge (Specify Setting)

## Standard Model Specifications – continued Model 122



6	Additional Options
<b>O</b>	None
<b>A</b>	Reversed High / Low Process Connections.
<b>E</b>	Two (2) 1/4-20 Mounting Holes
<b>L</b>	Liquid Fill (4-1/2" available with "G" option Aluminum Dial Case only) (not available with shatter proof lens)
<b>M</b>	Maximum Indicator Follower Pointer (Not available with Liquid fill ) (not available with shatter proof lens)
<b>S</b>	Shatter Proof Glass Lens (only available with 4-1/2" option "G" Aluminum Dial Case) (not available w/shatter proof lens)
<b>T</b>	Oxygen Cleaning
<b>U</b>	Stainless Steel Tag with S.S. Wire
<b>V</b>	Stainless Steel Tag and S.S. Screw (Contact factory on switch options)
<b>W</b>	Wall Mount Kit
<b>Z</b>	Special ( <i>Un-coded Options</i> )
<b>Note: Not All Options Available in Combination with other Options</b>	
7	Electrical Configurations (All options CE marked )
<b>M</b>	One (1) Reed Switch (Clamp-On)
<b>N</b>	Two (2) Reed Switches (Clamp-On)
<b>Z</b>	Special ( <i>Un-Coded Options</i> )
<b>Note: M &amp; N OPTIONS HAVE 22 AWG LEADS – 24" LENGTHS</b>	
8	Electrical Specifications (For Resistive Loads)
<b>A</b>	SPDT 3W, 0.25 Amp, 125 VAC/VDC (standard) (Switch adjustable range of 10-100%)
<b>E</b>	SPST 60W, 3.0 Amp, 240 VAC/VDC (Normally Open) (Switch adjustable range of 25-100%)
<b>H</b>	SPDT 60W, 1.0 Amp, 240 VAC/VDC (Switch adjustable range of 25-100%)
<b>Z</b>	Special ( <i>Un-Coded Options</i> )

**MID-WEST INSTRUMENT** has been serving a variety of industries (Power, Chemical, Petro-Chemical, HVAC, Water Filtration etc...) for over 50 years. Over 700,000 piston type units have been produced bearing the Mid-West name or private branded for our OEM customers!

Mid-West understands that in today's demanding environment, flexibility, quick response time and the ability to ship most of our product line in 2 weeks or less is essential to our customers. Standard configurations can be customized and modified to suit our customer's needs for ease of installation or retrofit.

If you are in need of additional information please visit our web site at [www.midwestinstrument.com](http://www.midwestinstrument.com) or contact us toll free at **1-800-648-5778** and one of our knowledgeable sales coordinators will be happy to assist you...







# Mid-West<sup>®</sup> Instrument



## “Piston Type” Differential Pressure Gauges Switches & Transmitters Model 123

A low cost differential pressure gauge for use in measuring the pressure drop across filters, strainers, separators, valves, pumps, chillers, etc., and for local flow indication and control.



Model 123  
0-400 PSID  
2-1/2" Dial

- Simple, rugged, compact design.
- Working pressure up to 5,000 PSIG (340 bar)
- Over-range protection to maximum pressure.
- Body materials: Aluminum or 316L Stainless Steel with 316 stainless steel internals.
- Weather-resistant construction standard.
- Shatter resistant acrylic lens.
- Variety of Dial type and Sizes: 2-1/2", 3-1/2", & 4-1/2"
- Available DP Ranges: Inches H<sub>2</sub>O, PSID, bar, and Kpa
- 1/4" FNPT & 1/2" FNPT Process Connections
- Multiple mounting options available
- Temperature Limits: -40°F(-40°C) to +200°F(+93°C)

Due to precision sizing of piston and body bore, leakage across piston will not exceed 15 SCFH air at 100 PSID at ambient temperature.

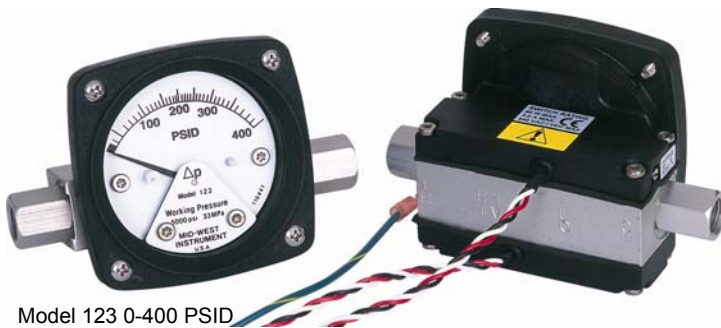

Model 123 0-400 PSID  
Shown with 2 Std. Switches



Model 123  
0-300 PSID 4-1/2" Dial

An optional maximum indication follower pointer provides automatic indication of maximum differential occurring during a time period or system cycle. Reversed pressure ports are optionally available to facilitate installation and readability depending on which side of a filter, etc., the instrument must be installed.

Model	Body Material	Accuracy	Min. ΔP Range	Max. ΔP Range	MWP PSIG (Bar)	Switch Options
123	Aluminum & 316L S.S.	±3/2/3%	0-150 PSID (0-10 bar)	0-400 PSID (0-27 bar)	ALM. = 3,000 (200) S.S. = 5,000 (340)	1 & 2 switch Hermetically Sealed

**Proof Pressure:** Two times rated working pressure at ambient temperature

**Standards:** Model 123 gauge either conforms to and / or is designed to the requirements of the following standards:

ASME B1.20.1	NACE MR0175
ASME B40.100	NEMA Std. No. 250
CSA-C22.2 No. 14.25 and 30	SAE J514
EN-61010-1	UL Std. No. 50,508 and 1203

# “Piston Type” Differential Pressure Gauge Switch & Transmitter Options Models 120, 122, 123 & 124



The Model 120-124 Series DP gauges are available with one or two hermetically sealed reed switches or 4-20mA transmitter depending on model. (See chart below)

The switches are adjustable (see table for adjustment range) within a defined percentage of the full scale range of the gauge and are available in SPDT and SPST, normally open or normally closed configurations for various load power ratings. The switches can be set to activate or deactivate on rising or falling pressure.

The standard reed switch is enclosed in a weather-resistant plastic housing. Adjustment of the switch setting is made with an external screw adjustment.

The switch functionality will be different for gauges with bi-directional operation for positive and negative delta pressure. For example a SPDT switch with positive .P applied to the gauge, the red wire will be N.O. and the black will be N.C.. For negative .P the functionality will be reversed.

Location for a single SPDT (grommet or conduit) switch will be on the bottom of the gauge body for a normal port and on the top for a reverse port. Locations for a single SPST (grommet or conduit) N.O. or SPST N.C. switch will be on the bottom and top respectively for a normal port gauge. The locations will be reversed for a reverse port gauge.

A non-indicating (no dial) differential pressure switch is also available.

Hazardous Location switches are 3<sup>rd</sup> Party Certified Class I Div 2 or Class I Div 1 dependant on type of switch. Listings are for the entire design and not just the enclosure. Standard and weatherproof units are CE marked for conformance with the Low Voltage Directive to harmonized standard EN 61010-1.

Transmitters feature Microprocessor based, external zero interface, 8-28 Vdc loop powered, 2 wire interface. Standard output of 4-20mA with a max loop resistance of 1000 Ohms.

Model Type	•120, ^122,+123, +124 SPDT	•120,^122, •123, SPDT	•120, ^122,+123, +124 SPST NO	•120, •123,•124 SPST NC	•120, •123,•124 SPST NO/NC	121, 124 4-20mA
Power	3 W	60 W	60 W	60 W	60 W	4-20 mA Loop Power
Max Current	0.25 Amps	1.0 Amps	3.0 Amps	3.0 Amps	3.0 Amps	8-28 VDC Loop Powered 2-Wire interface
Max Voltage VAC/VDC	125	240	240	240	240	1000 Ohm max Loop resistance at 28 vdc
Setting Full Scale	•10-90%	•25-100%	•25-95%	•25-95%	•25-95%	20-100%
	^10-100%	^25-100%	^25-100%			
	+15-90%		+25-95%			
Hysteresis (Max / Norm)	10% / 5% (FS)	20% / 13% (FS)	15% / 8% (FS)	15% / 8% (FS)	15% / 8% (FS)	N/A
Repeatability	1% F.S.	1% F.S.	1% F.S.	1% F.S.	1% F.S.	1% F.S.
Leads 22 Awg	(3) 24"	(3) 24"	(2) 24"	(2) 24"	(2) 24"	N/A



# Mid-West<sup>®</sup> Instrument

## Standard Dial Ranges: Model 120, 122, 123, 124

Range Type			
PSID	Kpa	Bar	Dual Scale
0-5 PSID	0-35 Kpa	0-1.0 Bar	0-5 PSID & 0-0.35 Kg/Cm2
0-10 PSID	0-70 Kpa	0-1.6 Bar	0-5 PSID & 0-35 KPA
0-15 PSID	0-100 Kpa	0-2.0 Bar	0-10 PSID & 0-0.7 BAR
0-20 PSID	0-160 Kpa	0-2.5 Bar	0-10 PSID & 0-0.7 KG/CM2
0-25 PSID	0-250 kpa	0-4.0 Bar	0-10 PSID & 0-70 KPA
0-30 PSID	0-400 Kpa	0-6.0 Bar	0-100 PSID & 0-7 BAR
0-50 PSID	0-600 Kpa	0-7.0 Bar	0-100 PSID & 0-7 KG/CM2
0-60 PSID	0-700 Kpa		0-100 PSID & 0-700 KPA
0-75 PSID			0-15 PSID & 0-1 BAR
0-100 PSID			0-15 PSID & 0-1 KG/CM2
0-110 PSID			0-15 PSID & 0-100 KPA
**0-150 PSID			0-20 PSID & 0-1.4 BAR
**0-200 PSID			0-20 PSID & 0-140 KPA
**0-250 PSID			0-25 PSID & 0-1.75 BAR
**0-300 PSID			0-25 PSID & 0-1.75 KG/CM2
**0-400PSID			0-25 PSID & 0-175 KPA
			0-30 PSID & 0-2 BAR
<b>Bi-Directional</b>	<b>Bi-Directional</b>	<b>Bi-Directional</b>	0-30 PSID & 0-2 KG/CM2
5-0-5 PSID	40-0-40 Kpa	0.4-0-0.4 Bar	0-30 PSID & 0-200 KPA
10-0-10 PSID	60-0-60 Kpa	0.6-0-0.6 Bar	0-50 PSID & 0-3.5 BAR
15-0-15 PSID	100-0-100 Kpa	1-0-1 Bar	0-50 PSID & 0-3.5 KG/CM2
20-0-20 PSID	160-0-160 Kpa	1.6-0-1.6 Bar	0-50 PSID & 0-350 KPA
25-0-25 PSID	250-0-250 Kpa	2.5-0-2.5 Bar	0-75 PSID & 0-500 KPA
30-0-30 PSID	400-0-400 Kpa	4-0-4 Bar	
50-0-50 PSID	600-600 Kpa	6-0-6 Bar	
60-0-60 PSID			
100-0-100 PSID			

**Bi-Directional ranges available for Model 120 4-1/2" Dials only.**

The above mentioned ranges are some of the most popular requested today. Mid-West Instrument can provide special un-cataloged dial range requirements. As well as multiple scale dials, multiple color dials and special decals. Please consult factory for complete information.

Model	Min. ΔP Range	Max. ΔP Range
120	0-5 PSID (0-0.35 bar)	0-110 PSID (0-7 bar)
122	0-5 PSID (0-0.35 bar)	0-100 PSID (0-7 bar)
**123	0-150 PSID (0-10 bar)	0-400 PSID (0-27.0 bar)
**124	0-5 PSID (0-0.35 bar) 0-150 PSID (0-10 bar)	0-110 PSID (0-7 bar) 0-400 PSID (0-27.0 bar)

**Proof Pressure:** Two times rated working pressure at ambient temperature

**Temperature Limits:** -40°F(-40°C) to +200°F(+93°C)

Transmitter Option: -20°F(-28°C) to +150°F(+65°C)

These limits are based on the entire instrument being saturated to these temperatures. System (process) temperatures may exceed these limitations with proper installation. Contact our customer service representative for details.

**Standards:** Model 120 -124 Series gauges either conform to and/or are designed to the requirements of the following standards:

ASME B1.20.1

ASME B40.100

CSA-C22.2 No. 14.25 and 30

EN-61010-1

NACE MR0175

NEMA Std. No. 250

SAE J514

UL Std. No. 50,508 and 1203

### Standard Model Specification: 123-AA-02-00

3000 PSIG Working Pressure, Aluminum Body & End Plugs, Stainless Steel Piston,  
Ceramic Magnet, Buna-N Seals, 1/4" FNPT End Connections, 2-1/2" round dial,  
Engineered Plastic Case with Shatter Resistant Acrylic Lens,  
Accuracy ±3/2/3% Full Scale (Ascending)

**Mid-West Instrument**

**1-800-648-5778**

**Range: 0-150 PSID to 0-400 PSID (0-10.3 bar to 0-27.5 bar)**

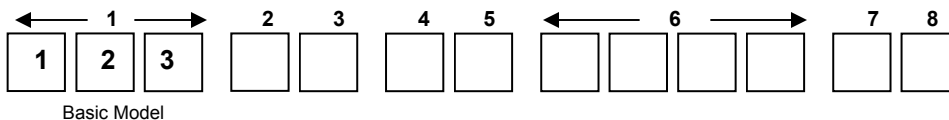

Range: \_\_\_\_\_



<b>2</b>	<b>Material</b>
<b>A</b>	Aluminum Body / Stainless Steel Piston
<b>S</b>	316 S.S Body / Stainless Steel Piston
<b>Z</b>	Special ( <i>Un-coded Options</i> )
<b>3</b>	<b>Dial Size &amp; Type</b>
<b>A</b>	2-1/2" Round Uni-Directional Dial w/Engineered Plastic Dial Case
<b>C</b>	4-1/2" Round Uni-Directional Dial w/Engineered Plastic Dial Case
<b>G</b>	4-1/2" Round Uni-Directional Dial w/Anodized Aluminum Housing Dial Case
<b>T</b>	Non-Indicating DP Switch Only
<b>Z</b>	Special ( <i>Un-coded Options</i> )
<b>4</b>	<b>Seal Materials</b>
<b>0</b>	Buna-N ( <b>Standard</b> )
<b>1</b>	Viton®-A Registered Trademark of Dupont
<b>2</b>	Neoprene
<b>5</b>	Ethylene Propylene
<b>9</b>	Special ( <i>Un-coded Options</i> )
<b>5</b>	<b>Process Connections</b>
<b>2</b>	1/4" FNPT End Connections ( <b>Standard</b> )
<b>4</b>	1/2" FNPT End Connections
<b>9</b>	Special ( <i>Un-coded Options</i> )

Factory preset switches at no charge (Specify Setting)

## Standard Model Specifications – continued Model 123

6	Additional Options
O	None
A	Reversed High / Low Process Connections.
C	Mounting Holes in Gauge Body for Field Mounting Electrical Configurations Options A & B
D	Mounting Holes in Gauge Body for Field Mounting Electrical Configurations Options L & M
E	Two (2) 1/4-20 Mounting Holes (not available with C, D, E or F electrical switch options)
F	Carbon Steel 2" Pipe Mounting Kit (not available with C, D, E or F electrical switch options)
G	Stainless Steel 2" Pipe Mounting Kit (not available with C, D, E or F electrical switch options)
L	Liquid Fill (4-1/2" available with "G" option Aluminum Dial Case only) (not available with shatter proof lens)
M	Maximum Indicator Follower Pointer (Not available with Liquid fill) (not available with shatter proof lens)
N	NACE
S	Shatter Proof Glass Lens (only available with 4-1/2" option "G" Aluminum Dial Case) (not available w/shatter proof lens)
T	Oxygen Cleaning
U	Stainless Steel Tag with S.S. Wire
V	Stainless Steel Tag and S.S. Screw
W	Wall Mount Kit (Not available with E&F switch option)
Z	Special ( <i>Un-coded Options</i> )
<b>NOTE: Not All Options Available in Combination with other Options</b>	
7	Electrical Configurations (CE marked, except E, F, J & K)
A	One (1) Switch in standard enclosure with grommet Wire Seal
B	Two (2) Switch in standard enclosures with grommet Wire Seal
C	One (1) Switch in standard enclosure with 1/4" FNPT electrical connection NEMA 4X
D	Two (2) Switch in standard enclosures with 1/4" FNPT electrical connection NEMA 4X
E	One (1) Switch in general purpose enclosure, Division 2 Hazardous Locations (1)
F	Two (2) Switches in general purpose enclosure, Division 2 Hazardous Locations (1)
L	One (1) Switch in standard enclosure with plug-in connector (DIN 43650/IP65-PG11)
M	Two (2) Switch in standard enclosures with plug-in connector (DIN 43650/IP65-PG11)
Z	Special ( <i>Un-coded Options</i> )
<b>(1) 3000 PSIG SWP for Aluminum</b>	
8	Electrical Specifications (For Resistive Loads)
A	SPDT 3W, 0.25 Amp, 125 VAC/VDC (standard) (Switch adjustable range of 15-90%)
E	SPST 60W, 3.0 Amp, 240 VAC/VDC (Normally Open) (Switch adjustable range of 25-95%)
F	SPST 60W, 3.0 Amp, 240 VAC/VDC (Normally Closed) (Switch adjustable range of 25-95%)
G	SPST 60W, 3.0 Amp, 240 VAC/VDC (1) Normally Open, (1) Normally Closed (Switch adjustable range of 25-95%)
H	SPDT 60W, 1.0 Amp, 240 VAC/VDC (Switch adjustable range of 25-95%)
Z	Special ( <i>Un-coded Options</i> )

**MID-WEST INSTRUMENT** has been serving a variety of industries (Power, Chemical, Petro-Chemical, HVAC, Water Filtration etc...) for over 50 years. Over 700,000 piston type units have been produced bearing the Mid-West name or private branded for our OEM customers!

Mid-West understands that in today's demanding environment, flexibility, quick response time and the ability to ship most of our product line in 2 weeks or less is essential to our customers. Standard configurations can be customized and modified to suit our customer's needs for ease of installation or retrofit.

If you are in need of additional information please visit our web site at [www.midwestinstrument.com](http://www.midwestinstrument.com) or contact us toll free at **1-800-648-5778** and one of our knowledgeable sales coordinators will be happy to assist you...



# Mid-West<sup>®</sup> Instrument

## “Piston Type”

### Differential Pressure Gauges Switches & Transmitters

## Model 124



A low cost differential pressure gauge for use in measuring the pressure drop across filters, strainers, separators, valves, pumps, chillers, etc., and for local flow indication and control.



Model 124  
0-150 PSID  
2-1/2" Dial

- Simple, rugged, compact design.
- Working pressure up to 10,000 PSIG (690 bar)
- Over-range protection to maximum pressure.
- Body materials: 316L Stainless Steel with 316 stainless steel internals.
- Weather-resistant construction standard.
- Shatter resistant acrylic lens.
- Variety of Dial type and Sizes: 2-1/2", 3-1/2" & 4-1/2"
- Available DP Ranges: Inches H<sub>2</sub>O, PSID, bar, and Kpa
- 1/4" FNPT & 1/2" FNPT Process Connections
- Multiple mounting options available
- Temperature Limits: -40°F(-40°C) to +200°F(+93°C)
- Transmitter Option: -20°F(-28°C) to +150°F(+65°C)

Due to precision sizing of piston and body bore, leakage across piston will not exceed 15 SCFH air at 100 PSID at ambient temperature.



Model 124  
0-75 PSID Shown with  
End Connections & Transmitter



Model 124  
0-300 PSID 4-1/2" Dial

An optional maximum indication follower pointer provides automatic indication of maximum differential occurring during a time period or system cycle. Reversed pressure ports are optionally available to facilitate installation and readability depending on which side of a filter, etc., the instrument must be installed.

Model	Body Material	Accuracy	Min. ΔP Range	Max. ΔP Range	MWP PSIG (Bar)	Switch Options
124	316L Stainless Steel	±3/2/3%	0-5 PSID (0-0.35 bar) 0-150 PSID (0-10.0 bar)	0-110 (0-7.0 bar) 0-400 (0-27.0 bar)	10,000 (690)	1 & 2 switch Hermetically Sealed or 4-20 mA Transmitter

**Proof Pressure:** Two times rated working pressure at ambient temperature

**Standards:** Model 124 gauge either conforms to and/or is designed to the requirements of the following standards:

ASME B1.20.1	NACE MR0175
ASME B40.100	NEMA Std. No. 250
CSA-C22.2 No. 14.25 and 30	SAE J514
EN-61010-1	UL Std. No. 50,508 and 1203

# “Piston Type” Differential Pressure Gauge Switch & Transmitter Options Models 120, 122, 123 & 124



The Model 120-124 Series DP gauges are available with one or two hermetically sealed reed switches or 4-20mA transmitter depending on model. (See chart below)

The switches are adjustable (see table for adjustment range) within a defined percentage of the full scale range of the gauge and are available in SPDT and SPST, normally open or normally closed configurations for various load power ratings. The switches can be set to activate or deactivate on rising or falling pressure.

The standard reed switch is enclosed in a weather-resistant plastic housing. Adjustment of the switch setting is made with an external screw adjustment.

The switch functionality will be different for gauges with bi-directional operation for positive and negative delta pressure. For example a SPDT switch with positive .P applied to the gauge, the red wire will be N.O. and the black will be N.C.. For negative .P the functionality will be reversed.

Location for a single SPDT (grommet or conduit) switch will be on the bottom of the gauge body for a normal port and on the top for a reverse port. Locations for a single SPST (grommet or conduit) N.O. or SPST N.C. switch will be on the bottom and top respectively for a normal port gauge. The locations will be reversed for a reverse port gauge.

A non-indicating (no dial) differential pressure switch is also available.

Hazardous Location switches are 3<sup>rd</sup> Party Certified Class I Div 2 or Class I Div 1 dependant on type of switch. Listings are for the entire design and not just the enclosure. Standard and weatherproof units are CE marked for conformance with the Low Voltage Directive to harmonized standard EN 61010-1.

Transmitters feature Microprocessor based, external zero interface, 8-28 Vdc loop powered, 2 wire interface. Standard output of 4-20mA with a max loop resistance of 1000 Ohms.

Model Type	•120, ^122,+123, +124 SPDT	•120,^122, •123, SPDT	•120, ^122,+123, +124 SPST NO	•120, •123,•124 SPST NC	•120, •123,•124 SPST NO/NC	121, 124 4-20mA
Power	3 W	60 W	60 W	60 W	60 W	4-20 mA Loop Power
Max Current	0.25 Amps	1.0 Amps	3.0 Amps	3.0 Amps	3.0 Amps	8-28 VDC Loop Powered 2-Wire interface
Max Voltage VAC/VDC	125	240	240	240	240	1000 Ohm max Loop resistance at 28 vdc
Setting Full Scale	•10-90%	•25-100%	•25-95%	•25-95%	•25-95%	20-100%
	^10-100%	^25-100%	^25-100%			
	+15-90%		+25-95%			
Hysteresis (Max / Norm)	10% / 5% (FS)	20% / 13% (FS)	15% / 8% (FS)	15% / 8% (FS)	15% / 8% (FS)	N/A
Repeatability	1% F.S.	1% F.S.	1% F.S.	1% F.S.	1% F.S.	1% F.S.
Leads 22 Awg	(3) 24"	(3) 24"	(2) 24"	(2) 24"	(2) 24"	N/A





# Mid-West<sup>®</sup> Instrument

## Standard Dial Ranges: Model 120, 122, 123, 124

Range Type			
PSID	Kpa	Bar	Dual Scale
0-5 PSID	0-35 Kpa	0-1.0 Bar	0-5 PSID & 0-0.35 Kg/Cm2
0-10 PSID	0-70 Kpa	0-1.6 Bar	0-5 PSID & 0-35 KPA
0-15 PSID	0-100 Kpa	0-2.0 Bar	0-10 PSID & 0-0.7 BAR
0-20 PSID	0-160 Kpa	0-2.5 Bar	0-10 PSID & 0-0.7 KG/CM2
0-25 PSID	0-250 kpa	0-4.0 Bar	0-10 PSID & 0-70 KPA
0-30 PSID	0-400 Kpa	0-6.0 Bar	0-100 PSID & 0-7 BAR
0-50 PSID	0-600 Kpa	0-7.0 Bar	0-100 PSID & 0-7 KG/CM2
0-60 PSID	0-700 Kpa		0-100 PSID & 0-700 KPA
0-75 PSID			0-15 PSID & 0-1 BAR
0-100 PSID			0-15 PSID & 0-1 KG/CM2
0-110 PSID			0-15 PSID & 0-100 KPA
**0-150 PSID			0-20 PSID & 0-1.4 BAR
**0-200 PSID			0-20 PSID & 0-140 KPA
**0-250 PSID			0-25 PSID & 0-1.75 BAR
**0-300 PSID			0-25 PSID & 0-1.75 KG/CM2
**0-400PSID			0-25 PSID & 0-175 KPA
			0-30 PSID & 0-2 BAR
<b>Bi-Directional</b>	<b>Bi-Directional</b>	<b>Bi-Directional</b>	0-30 PSID & 0-2 KG/CM2
5-0-5 PSID	40-0-40 Kpa	0.4-0-0.4 Bar	0-30 PSID & 0-200 KPA
10-0-10 PSID	60-0-60 Kpa	0.6-0-0.6 Bar	0-50 PSID & 0-3.5 BAR
15-0-15 PSID	100-0-100 Kpa	1-0-1 Bar	0-50 PSID & 0-3.5 KG/CM2
20-0-20 PSID	160-0-160 Kpa	1.6-0-1.6 Bar	0-50 PSID & 0-350 KPA
25-0-25 PSID	250-0-250 Kpa	2.5-0-2.5 Bar	0-75 PSID & 0-500 KPA
30-0-30 PSID	400-0-400 Kpa	4-0-4 Bar	
50-0-50 PSID	600-600 Kpa	6-0-6 Bar	
60-0-60 PSID			
100-0-100 PSID			

**Bi-Directional ranges available for Model 120 4-1/2" Dials only.**

The above mentioned ranges are some of the most popular requested today. Mid-West Instrument can provide special un-cataloged dial range requirements. As well as multiple scale dials, multiple color dials and special decals. Please consult factory for complete information.

Model	Min. ΔP Range	Max. ΔP Range
120	0-5 PSID (0-0.35 bar)	0-110 PSID (0-7 bar)
122	0-5 PSID (0-0.35 bar)	0-100 PSID (0-7 bar)
**123	0-150 PSID (0-10 bar)	0-400 PSID (0-27.0 bar)
**124	0-5 PSID (0-0.35 bar) 0-150 PSID (0-10 bar)	0-110 PSID (0-7 bar) 0-400 PSID (0-27.0 bar)

**Proof Pressure:** Two times rated working pressure at ambient temperature

**Temperature Limits:** -40°F(-40°C) to +200°F(+93°C)

Transmitter Option: -20°F(-28°C) to +150°F(+65°C)

These limits are based on the entire instrument being saturated to these temperatures. System (process) temperatures may exceed these limitations with proper installation. Contact our customer service representative for details.

**Standards:** Model 120 -124 Series gauges either conform to and/or are designed to the requirements of the following standards:

ASME B1.20.1

ASME B40.100

CSA-C22.2 No. 14.25 and 30

EN-61010-1

NACE MR0175

NEMA Std. No. 250

SAE J514

UL Std. No. 50,508 and 1203

## Standard Model Specification: 124-SA-00-00

10,000 PSIG Working Pressure, 316L Stainless Steel Body, Stainless Steel Piston,  
Ceramic Magnet, Buna-N Seals, 1/4" FNPT Back Connections, 2-1/2" round dial,  
Engineered Plastic Case with Shatter Resistant Acrylic Lens,  
Accuracy  $\pm 3/2/3\%$  Full Scale (Ascending)

**Mid-West Instrument** Range: 0-5 PSID to 0-110 PSID (0-.35 bar to 0-7.0 bar)

**1-800-648-5778** Range: 0-150 PSID to 0-400 PSID (0-10.3 bar to 0-27.5 bar) (*End connections only*)

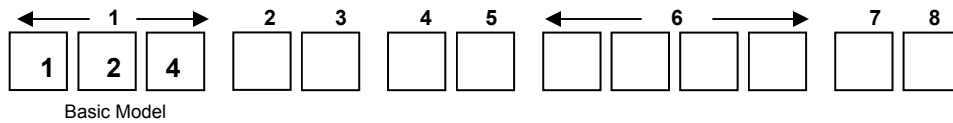

Range: \_\_\_\_\_



<b>2</b>	<b>Material</b>
<b>S</b>	316 S.S Body / Stainless Steel Piston
<b>Z</b>	Special ( <i>Un-coded Options</i> )
<b>3</b>	<b>Dial Size &amp; Type</b>
<b>A</b>	2-1/2" Round Uni-Directional Dial w/Engineered Plastic Dial Case
<b>C</b>	4-1/2" Round Uni-Directional Dial w/Engineered Plastic Dial Case
<b>E</b>	3-1/2" Round Uni-Directional Dial w/Anodized Aluminum Housing Dial Case
<b>G</b>	4-1/2" Round Uni-Directional Dial w/Anodized Aluminum Housing Dial Case
<b>T</b>	Non-Indicating DP Switch Only
<b>Z</b>	Special ( <i>Un-coded Options</i> )
<b>4</b>	<b>Seal Materials</b>
<b>0</b>	Buna-N ( <b>Standard</b> )
<b>1</b>	Viton®-A Registered Trademark of Dupont
<b>5</b>	Ethylene Propylene
<b>9</b>	Special ( <i>Un-coded Options</i> )
<b>5</b>	<b>Process Connections</b>
<b>0</b>	1/4" FNPT Back Connections ( <b>Standard</b> )
<b>2</b>	1/4" FNPT End Connections
<b>4</b>	1/2" FNPT End Connections
<b>9</b>	Special ( <i>Un-coded Options</i> )

**Factory preset switches at no charge (Specify Setting)**

## Standard Model Specifications – continued Model 124

6	Additional Options
<b>O</b>	NONE
<b>A</b>	Reversed High / Low Process Connections ( <b>Not available with switch or transmitter</b> )
<b>E</b>	Two (2) 1/4-20 Mounting Holes
<b>F</b>	Carbon Steel 2" Pipe Mounting Kit
<b>G</b>	Stainless Steel 2" Pipe Mounting Kit
<b>K</b>	1/2" FNPT S.S. Adapter ( <b>Back Connections Only</b> )
<b>L</b>	Liquid Fill (4-1/2" available with "G" option Aluminum Dial Case only) (not available with shatter proof lens)
<b>M</b>	Maximum Indicator Follower Pointer (Not available with Liquid fill) (not available with shatter proof lens)
<b>N</b>	NACE
<b>S</b>	Shatter Proof Glass Lens (only available with 4-1/2" option "G" Aluminum Dial Case) (not available w/shatter proof lens)
<b>T</b>	Oxygen Cleaning
<b>U</b>	Stainless Steel Tag with S.S. Wire
<b>W</b>	Wall Mount Kit (Not available with back connections)
<b>Z</b>	Special ( <b>Un-coded Options</b> )
<b>NOTE: Not All Options Available in Combination with other Options</b>	
7	Electrical Configurations (CE marked, except E, F)
<b>O</b>	NONE
<b>C</b>	One (1) Reed switch in NEMA 4X/IP65 Plastic enclosure with terminal strip (1/2" FNPT Conduit Connection)
<b>D</b>	Two (2) Reed switches in NEMA 4X/IP65 Plastic enclosure with terminal strip (1/2" FNPT Conduit Connection)
<b>T</b>	4-20 mA Transmitter in NEMA 4X/IP65 Plastic enclosure with terminal strip (1/2" FNPT Conduit Connection) Temperature Limit: -20°F(-28°C) to +150°F(+65°C)
<b>Z</b>	Special ( <b>Un-coded Options</b> )
8	Electrical Specifications (For Resistive Loads)
<b>A</b>	SPDT 3W, 0.25 Amp, 125 VAC/VDC (standard) (Switch adjustable range of 15-90%)
<b>E</b>	SPST 60W, 3.0 Amp, 240 VAC/VDC (Normally Open) (Switch adjustable range of 25-95%)
<b>F</b>	SPST 60W, 3.0 Amp, 240 VAC/VDC (Normally Closed) (Switch adjustable range of 25-95%)
<b>G</b>	SPST 60W, 3.0 Amp, 240 VAC/VDC (1) Normally Open, (1) Normally Closed (Switch adjustable range of 25-95%)
<b>T</b>	4-20 mA Transmitter (8-28 VDC Loop Power) ( ±2% accuracy from 20% to 100% of scale. Ascending)
<b>Z</b>	Special ( <b>Un-coded Options</b> )

**MID-WEST INSTRUMENT** has been serving a variety of industries (Power, Chemical, Petro-Chemical, HVAC, Water Filtration etc...) for over 50 years. Over 700,000 piston type units have been produced bearing the Mid-West name or private branded for our OEM customers!

Mid-West understands that in today's demanding environment, flexibility, quick response time and the ability to ship most of our product line in 2 weeks or less is essential to our customers. Standard configurations can be customized and modified to suit our customer's needs for ease of installation or retrofit.

If you are in need of additional information please visit our web site at [www.midwestinstrument.com](http://www.midwestinstrument.com) or contact us toll free at **1-800-648-5778** and one of our knowledgeable sales coordinators will be happy to assist you...





# Mid-West<sup>®</sup> Instrument

## “Piston Type” Model 220

### “Hazardous Locations”



## Indicating / Non-Indicating Differential Pressure Switch or Transmitter



- Low cost piston type differential pressure switch for use in measuring or controlling the pressure drop cross filters, strainers, separators, valves and pumps.
- Simple rugged compact design
- Working Pressure 4,000 PSIG (275 bar)
- Over-range protection to maximum pressure.
- 316 S.S. wetted pressure containing body assembly.
- Wetted Internals –  
316 Stainless Steel and Ceramic moving components.
- Weather resistant gauge construction standard.
- Dial Size: 4-1/2” with Shatter resistant acrylic lens.
- Five Year Limited Warranty

- Field wireable terminal strip interface.
- Up to 10A 120/240 VAC switching with DPDT Relay outputs.
- Hermetically Sealed Switch Outputs up to 3 Amps in SPST configuration and up to 1 Amp in SPDT configuration
- SPST outputs available in Normally Open or Normally Closed configurations
- Up to (2) independent adjustable switch points.
- 4-20 mA Transmitter with 8-28 Vdc loop power
- ½” FNPT conduit cable interface with internal terminal strip
- CSA & UL Certified to US and Canadian standards.
- CSA & UL Certified:
  - Class I, Division 1 / Groups B, C & D
  - Class II, Division 1 / Groups E, F & G
  - Class I, Division 2 / Groups A, B, C & D
  - Class II, Division 2 / Groups F & G
- Certified for ATEX / IECEx
  - Ex d IIB + H<sub>2</sub> Ex tb IIIC, IP65 (3000 PSIG SWP)
  - Division 2 Units are NEMA 4X

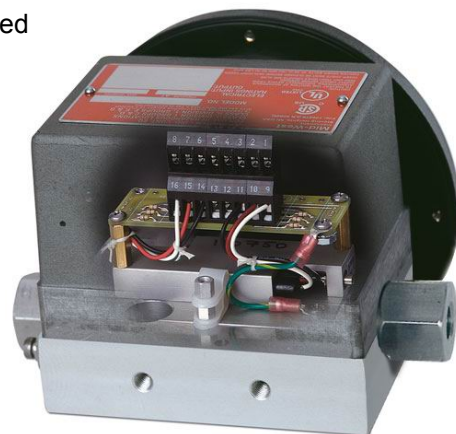

Model	Body Material	Accuracy	Min. ΔP Range	Max. ΔP Range	MWP PSIG (Bar)	Switch Options
220	316L S.S.	±2%	0-5 PSID (0-0.35 bar)	0-100 PSID (0-7 bar)	**4,000 (275)	1 or 2 switches or 4-20mA Transmitter

\*\*3,000 PSIG SWP for ATEX RATED UNITS

**NOTE:** Due to precision sizing of the piston and the body, bore leakage across the piston will not exceed 15 SCFH air at 100 PSID at ambient conditions. **This gauge should not be used in Hazardous Environments with low process port open to atmosphere.**

# “Piston Type” Differential Pressure Gauge Switch Options Model 220

The switching components are housed under a copper free Aluminum cover the combination of the gauge body and the cover make up the flame-proof seal. Electrical interface to the internal field wire terminal strip is via ½” NPT industry standard conduit connection located through the gauge body.

The hazardous environment indicating differential pressure switch is available with one or two hermetically sealed reed switches with optional one or two DPDT relay outputs. Each switch is independently adjustable within a defined percentage of the full scale range of the gauge and is available in SPDT and SPST (normally open or normally closed) for various load power ratings. The switches can be set to activate or deactivate on rising or falling differential pressure. If the optional relay output is specified, an input operating voltage must also be specified.

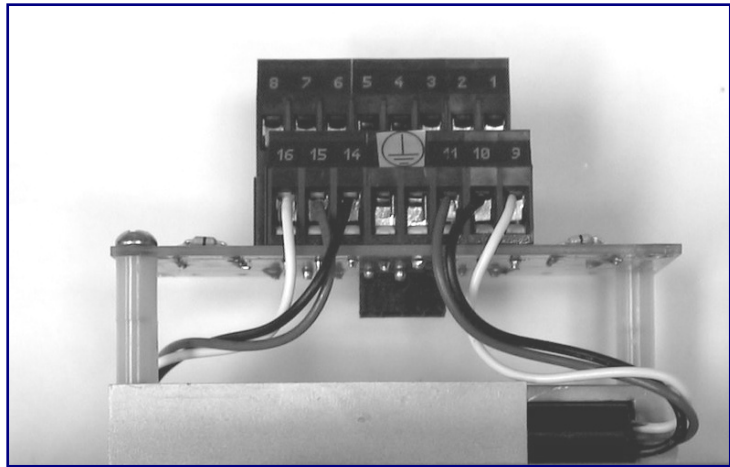

## OUTPUT RATINGS (Resistive Load)

Type	SPST	SPDT	SPDT	DPDT Relay
Electrical Specification Input Option	A	A	A	B,C,D,E,F,G,H
Electrical Specification Output Option	E, F or G	H	A	R
*Power	60 W	60 W	3W	N/A
Maximum Current	3 Amps	1.0 Amps	0.25 Amps	10 Amps
Max. Volts VAC/VDC	240	240	125	277 / 30
Setting (Full Scale) **	15% to 90%	25% to 90%	10% to 90%	15% to 90%
Hysteresis Full Scale	20% / 9% (Max / Nom)	20% / 18% (Max / Nom)	10% / 6% (Max / Nom)	20% / 10% (Max / Nom)
Repeatability	1% Full Scale	1% Full Scale	1% Full Scale	1% Full Scale

\* Product of the switching voltage and current shall not exceed the power rating of device

\*\*For ranges ≥60 PSID, minimum adjustability = 25%

**Warning:** The suitability of the application and installation of this differential pressure switch is the responsibility of the end user. The applicable certifications, listings apply to the differential pressure switch only.

# “Piston Type” Differential Pressure Gauge Transmitter Option Model 220

Model 220 Transmitter provides a simple low cost loop powered 8-28 Vdc two wire 4-20 mA transmitter with highly visible local display allowing for monitoring at the unit and in the control room.

The transmitter utilizes the same CSA, UL and ATEX rated sensor and explosion proof housing as on the Model 240 explosion proof switch. Although the transmitter option is not yet listed, the sensors and explosion proof housing are rated Class I, Division 1 Groups B, C & D. Class II, Division 1 Groups E, F & G and Ex d IIB + H2, Ex tb IIIC, IP65 (3000 PSIG SWP). Each transmitter is individually calibrated to the gauge using an 11 point calibration linearization technique.

<b>TRANSMITTER SPECIFICATIONS</b>				
<b>Transmitter Specifications: Comments:</b>				
<b>Differential Pressure Range</b>	0-5 PSID to 0-100 PSID			
<b>Leakage</b>	15SCFH @ 100 PSID Max Hi to Lo		Not recommended for use with Lo port left open to atmosphere	
<b>Pressure (Ratings)</b>				
<b>Max Working</b>	3000 PSIG			
<b>Gauge Accuracy</b>	2%		ASME B40.100 GRADE B	
<b>Operating Temperature (Max.)</b>	-20°F -150°F			
<b>ELECTRICAL:</b>				
	<b>Min</b>	<b>Typ</b>	<b>Max</b>	
<b>Transmitter Accuracy (FSR)</b>			2%	Upper 80% of Full Scale Range
<b>Supply Voltage (3) (Vdc)</b>	8		28	Pin 3 Reverse Polarity Protected
<b>Output Current (ma)</b>				
<b>Zero Floating (2)</b>	4.0 – 20.1 ma	4.0 – 21.0	4.0 – 22.0	Pin 2
<b>Zeroed (1 connected to 2)</b>		8		
<b>Voltage (Pin 2 to 1)</b>	4.8		6.3	
<b>Zero Time (seconds)</b>	2			
<b>Max Loop Resistance (ohms)</b>			1000	
<b>Max Loop Resistance Formula</b>	$((V_s - 8) / 20) * 1000$			
<b>INTERFACE:</b>				
<b>Electrical:</b>				
<b>Connections:</b>	4 Position Terminal Strip; ½" NPT Conduit 1= Rtn, 2= Zero, 3 = 8-28 Vdc In, 4= Chassis		22 Awg – 12Awg Wire	
<b>Environmental Rating:</b>	Explosion-proof Enclosure rated Class I, Div I, Groups B, C, D; Class II, Div I, Groups E, F, & G **			
<b>Certifications:</b>	Ex d IIB + H2 T6 (-30°C ≤ Ta ≤ 65°C)Gb Ex tb IIIC IP65 T85°C (-30°C ≤ Ta ≤ 65°C )Gd ATEX and IECEx			

**PROOF PRESSURE:** 8,000 PSI. (6,000 PSI for Transmitter)

**TEMPERATURE LIMITS: -40°F (-40°C) to +185°F (+85°C)**– For electrical Input Options A in combination with electrical output options A, E, F, G & H. These limits are based on the entire instrument being saturated to these temperatures. System (process) temperatures may exceed these limitations with proper installation. Contact our customer service representative for details.

**-40°F (-40°C) to +160°F (+70°C) – For output option R (Relay Output)**

**-20°F (-30°C) to +150°F (+65°C) – For output option 4-20 mA Transmitter**

**STANDARDS:** The Model 240 Series differential pressure gauge either conforms to and/or is designed to the requirements of the following standards:

ASME B1.20.1	NEMA Std. No. 250
ASME B40.100	SAE J514
CSA-C22.2 No. 14, 25 and 30	EN60079-0, EN60079-1 & EN13463-1
UL Std. No. 50, 508, 698, and 1203	IEC 60079-31

# Mid-West<sup>®</sup> Instrument

## Standard Dial Ranges: Model 220

Range Type			
PSID	Kpa	Bar	Dual Scale
0-5 PSID	0-35 Kpa	0-1.0 Bar	0-5 PSID & 0-0.35 Kg/Cm2
0-10 PSID	0-70 Kpa	0-1.6 Bar	0-5 PSID & 0-35 KPA
0-15 PSID	0-100 Kpa	0-2.0 Bar	0-10 PSID & 0-0.7 BAR
0-20 PSID	0-160 Kpa	0-2.5 Bar	0-10 PSID & 0-0.7 KG/CM2
0-25 PSID	0-250 kpa	0-4.0 Bar	0-10 PSID & 0-70 KPA
0-30 PSID	0-400 Kpa	0-6.0 Bar	0-100 PSID & 0-7 BAR
0-50 PSID	0-600 Kpa	0-7.0 Bar	0-100 PSID & 0-7 KG/CM2
0-60 PSID	0-700 Kpa		0-100 PSID & 0-700 KPA
0-75 PSID			0-15 PSID & 0-1 BAR
0-100 PSID			0-15 PSID & 0-1 KG/CM2
			0-15 PSID & 0-100 KPA
			0-20 PSID & 0-1.4 BAR
			0-20 PSID & 0-140 KPA
			0-25 PSID & 0-1.75 BAR
			0-25 PSID & 0-1.75 KG/CM2
			0-25 PSID & 0-175 KPA
			0-30 PSID & 0-2 BAR
			0-30 PSID & 0-2 KG/CM2
			0-30 PSID & 0-200 KPA
			0-50 PSID & 0-3.5 BAR
			0-50 PSID & 0-3.5 KG/CM2
			0-50 PSID & 0-350 KPA
			0-75 PSID & 0-500 KPA

The above mentioned ranges are some of the most popular requested today. Mid-West Instrument can provide special un-cataloged dial range requirements. As well as multiple scale dials, multiple color dials and special decals. Please consult factory for complete information.

Model	Min. ΔP Range	Max. ΔP Range
220	0-5 PSID (0-0.35 bar)	0-100 PSID (0-7 bar)

**PROOF PRESSURE:** 16,000 PSI.

**TEMPERATURE LIMITS: -40°F (-40°C) to +185°F (+85°C)**– For electrical Input Options A in combination with electrical output options A, E, F, G & H. These limits are based on the entire instrument being saturated to these temperatures. System (process) temperatures may exceed these limitations with proper installation. Contact our customer service representative for details.

**-40°F (-40°C) to +160°F (+70°C) – For output option R (Relay Output)**  
**-20°F (-30°C) to +150°F (+65°C) – For output option 4-20 mA Transmitter**

**STANDARDS:** The Model 240 Series differential pressure gauge either conforms to and/or is designed to the requirements of the following standards:

ASME B1.20.1	NEMA Std. No. 250
ASME B40.100	SAE J514
CSA-C22.2 No. 14, 25 and 30	EN60079-0, EN60079-1 & EN61241-0
UL Std. No. 50, 508, 698, and 1203	EN61241-1, EN13463-1



## Standard Model Specifications: 220SC02-O-JAA

4000 PSIG Working Pressure, 316 S.S. wetted pressure containing body assembly, Stainless Steel/Ceramic Magnet internals, Buna-N Seals, 1/4" FNPT End Connections, 4-1/2" round dial, engineered plastic dial case with Shatter Resistant Acrylic Lens, (1) 3W 125 VAC/VDC SPDT reed switch with terminal strip, aluminum explosion proof switch enclosure and 1/2" FNPT electrical access.

**Mid-West Instrument**  
1-800-648-5778

**Complete assembly 3<sup>rd</sup> Party Certified**  
**Range 0-5 PSID to 0-100PSID (0-.35 bar to 0-7.0 bar)**

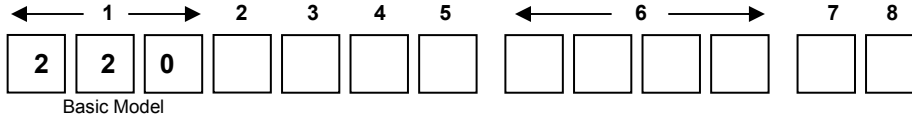

Range: \_\_\_\_\_



2	Material
<b>S</b>	316/316L S.S Wetted Pressure Containing Body Assembly Wetted Internals: Stainless Steel Piston & Ceramic moving components
<b>Z</b>	Special ( <i>Un-coded Options</i> )
3	Dial Size & Type
<b>C</b>	4-1/2" Round Uni-Directional Dial w/Engineered Plastic Dial Case
<b>F</b>	4-1/2" Round Uni-Directional Dial w/Anodized Aluminum Housing Dial Case
<b>T</b>	Non-Indicating DP Switch Only
<b>Z</b>	Special ( <i>Un-coded Options</i> )
4	Seal Materials
<b>0</b>	Buna-N ( <b>Standard</b> )
<b>1</b>	Viton®-A Registered Trademark of Dupont
<b>2</b>	Neoprene
<b>5</b>	Ethylene Propylene
<b>6</b>	Perfluorelastomers
<b>9</b>	Special ( <i>Un-coded Options</i> )
5	Process Connections
<b>2</b>	1/4" FNPT End Connections ( <b>Standard</b> )
<b>7</b>	1/2" FNPT End Connections
<b>9</b>	Special ( <i>Un-coded Options</i> )
6	Additional Options
<b>O</b>	None
<b>F</b>	Carbon Steel 2" Pipe Mounting Kit
<b>G</b>	Stainless Steel 2" Pipe Mounting Kit
<b>M</b>	Maximum Indicator Follower Pointer ( <b>Not available with Electrical Configurations R &amp; S</b> )
<b>Q</b>	CRN ( <b>Canadian Registration Number</b> )
<b>S</b>	Shatter Proof Glass Lens ( <b>Available with 4-1/2" Aluminum Dial Case only</b> )
<b>T</b>	Oxygen Cleaning
<b>U</b>	Stainless Steel Tag with S.S. Wire
<b>V</b>	Stainless Steel Tag with S.S. Screws
<b>Z</b>	Special ( <i>Un-Coded Options</i> )

**NOTE: Not All Options Available in Combination with other Options**

## Standard Model Specifications – continued Model 220

7	"MODEL 220" ELECTRICAL CONFIGURATIONS (T6 Temperature Class unless specified)
A	One (1) Control switch in NEMA-4X enclosure (1) (6) (8)
B	Two (2) Control switches in NEMA-4X enclosure (1) (6) (7) (8)
J	One (1) Control switch in NEMA 7 (Explosion Proof Enclosure) (2)
K	Two (2) Control switches in NEMA 7 (Explosion Proof Enclosure) (2) (7)
R	One (1) Control switch in Ex d Enclosure (CE marked) ATEX / IECEx (2) (9)
S	Two (2) Control switches in Ex d Enclosure (CE marked) ATEX / IECEx (2) (7) (9)
T	4-20 mA Transmitter in NEMA7/EEExd (Explosion Proof Enclosure) (9) (Temperature Limits -20°F to +150°F)
Z	Special (10)
8	"INPUT OPTIONS" ELECTRICAL SPECIFICATIONS (Select (1) input and (1) output option)
A	No Input power for reed outputs A, E, F, G & H
B	5/6 VDC
C	12 VDC
D	24 VDC
E	48 VDC
F	24 VAC
G	120 VAC
H	240 VAC (T4-ATEX; T4A-NORTH AMER.) TEMP CLASS
T	8-28 Vdc Loop Power (Option T only)
"OUTPUT OPTIONS" ELECTRICAL SPECIFICATIONS (Resistive Load) (3)	
A	SPDT, 3W, 0.25 Amp., 125 VAC/VDC (Switch Adjustable 15-90% of full scale ascending)
E	SPST, 60W, 3.0 Amp., 240 VAC/VDC (Normally Open) (Switch Adjustable 15-90% of full scale ascending)
F	SPST, 60W, 3.0 Amp., 240 VAC/VDC (Normally Closed) (Switch Adjustable 15-90% of full scale ascending)
G	SPST, 60W, 3.0 Amp., 240 VAC/VDC One (1) Normally Open, One (1) Normally Closed (B, K, & S Electrical Configurations only) (Switch Adjustable 15-90% of full scale ascending)
H	SPDT, 60W, 1.0 Amp., 240 VAC/VDC (Switch Adjustable 25-90% of full scale ascending)
R	DPDT, Relay, 10A @ 30 VDC, 120/240 VAC (Switch Adjustable 15-90% of full scale ascending) (8) (10)
T	4-20 mA Transmitter in general purpose enclosure, 3rd Party Certified Division 2 Hazardous Locations with Terminal Strip / 1/2" FNPT Conduit Connection (±2% accuracy from 20-100% of full scale ascending)
Z	Special (Contact Factory)
(1) Complete Assy. 3 <sup>rd</sup> Party Certified. Rated Class I, Div II, Groups A, B, C & D; Class II Div II Groups F&G (R output excluded)	
(2) Complete Assy. 3 <sup>rd</sup> Party Certified. Rated Class I, Div I, Groups B, C & D; Class II Div I Groups E, F&G	
(3) For output options A through H, the product switching voltage and current shall not exceed power rating.	
(6) Enclosure Type 4/4X	
(7) For electrical configuration B, K & S, SPDT relay output only	
(8) Electrical configuration A & B in combination with Output Option R is not rated for Hazardous Locations	
(9) Atex / IECEx Rated CE marked Ex d IIB + H <sub>2</sub> , Ex tb IIIC, IP65 (3000 PSIG SWP)	
(10) For Electrical configurations: B, K, & S, you must use SPDT relay output only.	

**MID-WEST INSTRUMENT** has been serving a variety of industries (Power, Chemical, Petro-Chemical, HVAC, Water Filtration etc...) for over 50 years. Over 700,000 piston type units have been produced bearing the Mid-West name or private branded for our OEM customers!

Mid-West understands that in today's demanding environment, flexibility, quick response time and the ability to ship most of our product line in 2 weeks or less is essential to our customers. Standard configurations can be customized and modified to suit our customer's needs for ease of installation or retrofit.

If you are in need of additional information please visit our web site at [www.midwestinstrument.com](http://www.midwestinstrument.com) or contact us toll free at **1-800-648-5778** and one of our knowledgeable sales coordinators will be happy to assist you...



# DIAPHRAGM STYLE GAUGE

---



For Installation and Operation Manuals  
Please Visit: [www.midwestinstrument.com/literature](http://www.midwestinstrument.com/literature)

---

**Mid-West**  
Instrument



# Mid-West<sup>®</sup> Instrument



## “Diaphragm Type”

## Differential Pressure Gauge & Switch

## Model 130



Shown here with  
Range 0-5" H<sub>2</sub>O

**Model 130** is a rugged general purpose differential pressure gauge with a 4-1/2" round dial.

**Common Applications:** Tank Level Monitoring Horizontal or Vertical Flow, Liquid Level, Indication/Balancing, Filter Monitoring for Gases, Water Treatment Applications and Vacuum Application



0-130 GPM  
Flow Gauge Scale

The low range capability of the **Model 130** is ideally suited for flow, liquid level and vacuum applications. Magnetic coupling between the sensing element and the indicating pointer provides for complete isolation of the process fluid within the pressure capsule. The few internal metal parts are 316L Stainless Steel.

*“A World Leader in Differential Pressure Gauges & Switches”*

### Model 130:

- Housing materials: Glass-Reinforced Engineered Plastic, Aluminum, Brass and 316L Stainless Steel
- Accuracy: 0-5" thru 0-9.9" H<sub>2</sub>O ±5% Full Scale Ascending  
0-10" thru 0-400" H<sub>2</sub>O ±2% Full Scale Ascending
- Weather-resistant construction standard.
- Use on virtually all reasonably clean liquids or gases.
- Over-range protection to full rated working pressure.
- Diaphragm design allows use of dissimilar fluids on high and low side of gauge.
- Can be used with vacuum or pressure applications
- Shatter resistant lens.
- 4-1/2" Engineered Plastic dial assembly standard.
- 1/4" FNPT & 1/2" FNPT Process Connections
- DP Ranges available in: Inches H<sub>2</sub>O, PSID, mbar, and Kpa
- Available with Square Root dials for flow measurement

Shown with  
Engineered Plastic Body



Shown with  
S.S. Cast Body

Model	Accuracy	Min. ΔP Range	Max. ΔP Range	MWP PSIG (bar)	Optional Switches
130	±2% or ±5%	0-5" H <sub>2</sub> O (0-12.4 mbar)	0-400" H <sub>2</sub> O (0-1 bar)	*300 (20) **500 (34)	1 & 2 Switches Hermetically Sealed

\*Glass-Reinforced Engineered Plastic \*\*Aluminum, Brass and Stainless Steel  
**Switches available on Aluminum, Brass & 316 S.S. bodies only.**

# “Diaphragm Type” Differential Pressure Gauge Switch Options Model 130



Model 130 in Explosion Proof (left) and NEMA 4X (right) enclosures

Shown w/Aluminum Body & (1) Reed Switch in Condulet enclosure

Model 130 is available in Aluminum, Brass and 316SS bodies only with one or two hermetically sealed reed switches for low and/or high limit alarm. These CSA listed switches are Single Pole Double Throw (SPDT) with adjustable set points. Switches can be set to activate/deactivate on rising or falling pressure. Switches are enclosed in a weather resistant housing. Switch setting is readily made with a screw adjustment.

CSA listed control switching is available in non-corrosive molded plastic enclosures. These are oil tight, dust tight and watertight per NEMA Type 4X standards.

CSA listed control switching is available in an explosion-proof enclosure which complies with NEC Class I, Groups C and D; Class II Groups E, F, and G; NEMA 7 and 9 standards. These are machined cast-aluminum enclosures with 1/2" FNPT conduit connection and 24" wire leads.



Shown w/Aluminum Body & (1) Reed Switch with Condulet enclosure and Plug-In Connector (Din 46350-PG 11)

Model Type	130 SPDT
Power	3 W
Max Current	0.25 Amps
Max Voltage VAC/VDC	125 VAC/VDC
Setting Full Scale	10-90%
Hysteresis (Max / Norm)	10% / 5% (FS)
Repeatability	1% F.S.
Connections	(3) 24" Leads 22 AWG



Shown in NEMA 4X Plastic enclosures

**Factory preset switch at no extra charge (Specify Setting)  
Specify increasing or decreasing range to be set.**

**Proof Pressure:** Two times rated working pressure at ambient temperature

**Temperature Limits:** -40°F (-40°C) to +200°F (+93°C) - These limits are based on the entire instrument being saturated to these temperatures. System (process) temperatures may exceed these limitations with proper installation. Contact our customer service representative for details.

**Standards:** Model 130 gauge either conforms to and/or is designed to the requirements of the following standards:

ASME B1.20.1	NACE MR0175
ASME B40.100	NEMA Std. No. 250
CSA-C22.2 No. 14.25 and 30	SAE J514
EN-61010-1	UL Std. No. 50,508 and 1203

# Mid-West<sup>®</sup> Instrument

## Standard Dial Ranges: Model 130

Range Type				
IN H <sub>2</sub> O	PSID	Kpa	mbar	Flow Scales
0-5"	0-5	0-1.6	0-16	0-1.0
0-10"	0-10	0-2.5	0-25	0-1.25
0-15"	0-15	0-4.0	0-40	0-1.5
0-20"		0-6.0	0-60	0-1.75
0-25"		0-10	0-100	0-2.0
0-30"		0-16	0-160	0-2.5
0-40"		0-25	0-250	0-3.0
0-50"		0-40	0-400	0-3.5
0-60"		0-60	0-600	0-4.0
0-75"		0-100	0-1000	0-4.5
0-100"				0-5.0
0-135"				0-5.5
0-150"				0-6.0
0-200"				0-6.5
0-300"				0-7.0
0-400"				0-7.5
				0-8.0
				0-8.5
				0-9.0
				0-9.5
				0-10

Available Multipliers for Flow Dials: X10, X100, X1000, and X10,000

Note: Not all ranges available in all diaphragm materials

The above mentioned ranges are some of the most popular requested today. Mid-West Instrument can provide special un-cataloged dial range requirements. As well as dual scale dials, multiple color dials and special decals. Please consult factory for complete information.

Model	Min. ΔP Range	Max. ΔP Range
130	0-5" H <sub>2</sub> O (0-12.4 mbar)	0-400" H <sub>2</sub> O (0-1 bar)

**Proof Pressure:** Two times rated working pressure at ambient temperature

**Temperature Limits:** -40°F (-40°C) to +200°F (+93°C) - These limits are based on the entire instrument being saturated to these temperatures. System (process) temperatures may exceed these limitations with proper installation. Contact our customer service representative for details.

**Standards:** Model gauge either conforms to and/or is designed to the requirements of the following standards:

ASME B1.20.1	NACE MR0175
ASME B40.100	NEMA Std. No. 250
CSA-C22.2 No. 14.25 and 30	SAE J514
EN-61010-1	UL Std. No. 50,508 and 1203



### Standard Model Specifications: 130-PC-00-00

Glass-Reinforced Engineered Plastic Body, 316 Stainless Steel Internal Metal Parts  
 Ceramic Magnet, Buna-N Diaphragm and Seals, 1/4" Steel Compression Tube Fittings,  
 4-1/2" round dial, Engineered Plastic Case with Shatter Resistant Acrylic Lens,  
 (Aluminum, Brass & Stainless Steel Bodies-Dual 1/4" FNPT Top & Bottom)  
 Accuracy ±5% Full Scale (Ascending) 0-5" H<sub>2</sub>O to 0-9.9" H<sub>2</sub>O or equivalent  
 Accuracy ±3/2/3% Full Scale (Ascending) 0-10" H<sub>2</sub>O to 0-400" H<sub>2</sub>O or equivalent

**Mid-West Instrument**  
 1-800-648-5778

**Range 0-5 IN H<sub>2</sub>O to 0-400 IN H<sub>2</sub>O (0-12.4 mbar to 0-1 bar)**

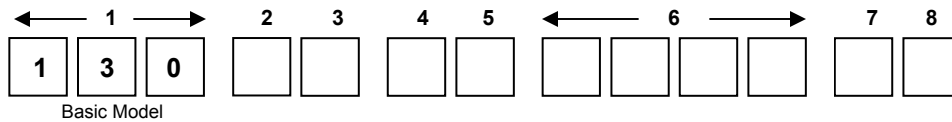

Range: \_\_\_\_\_



2	Material
P	Glass-Reinforced Egrd. Plastic Body / 316 Stainless Steel Internal Metal Parts (not available with switches)
A	Aluminum Body / 316 Stainless Steel Internal Metal Parts
B	Brass Body / 316 Stainless Steel Internal Metal Parts
S	316 Stainless Steel Body / 316 Stainless Steel Internal Metal Parts
Z	Special ( <b>Un-coded Options</b> )
3	Dial Size & Type
C	4-1/2" Round Uni-Directional Dial w/Engineered Plastic Housing Assembly
E	3-1/2" Round Uni-Directional Dial w/Anodized Aluminum Housing Dial Case
G	4-1/2" Round Uni-Directional Dial w/Anodized Aluminum Housing Dial Case
T	Non-Indicating DP Switch Only
Z	Special ( <b>Un-coded Options</b> )
4	Seal Materials
0	Buna-N
1	Viton ®-A Registered Trademark of Dupont (0-20" H <sub>2</sub> O to 0-400" H <sub>2</sub> O)
2	Silicone (0-5" H <sub>2</sub> O to 0-100" H <sub>2</sub> O)
4	Neoprene (0-5" H <sub>2</sub> O to 0-100" H <sub>2</sub> O)
5	Ethylene Propylene (0-20" H <sub>2</sub> O to 0-400" H <sub>2</sub> O)
9	Special ( <b>Un-coded Options</b> )
5	Process Connections
0	1/4" (2) (Carbon Steel Compression Tube Fittings Standard on "P" Gauge Body) 1/4" FNPT (4) (Standard on A, B, & S. Gauge Bodies)
1	1/4" (2) 316 Stainless Steel compression tube fittings
2	1/4" FNPT Brass Adapters (Model P only)
3	1/4" FNPT (2) Stainless Steel Adapters (Model P only)
9	Special ( <b>Un-coded Options</b> )

Factory preset switches at no charge (Specify Setting)

## Standard Model Specifications – continued Model 130

6	Additional Options
<b>O</b>	NONE
<b>B</b>	Drain & Bleed Plugs, 316 S.S. (2) <b>(Model 130 P only)</b>
<b>D</b>	Drain & Bleed in NEMA 4X enclosure
<b>F</b>	Carbon Steel 2" Pipe Mounting Kit
<b>G</b>	Stainless Steel 2" Pipe Mounting Kit
<b>H</b>	Hastelloy C Internal wetted Metal parts & fittings. <b>(Poly body only)</b>
<b>K</b>	1/2" FNPT S.S. Adapter (2) <b>(Available on "A", "B", &amp; "S" Gauge Body)</b>
<b>M</b>	Maximum Indicator Follower Pointer
<b>N</b>	NACE <b>(Contact Factory)</b>
<b>Q</b>	CRN (Candian Registration Number) <b>(available on Poly and S.S. gauge bodies only)</b>
<b>S</b>	Shatter Proof Glass Lens <b>(Available with 4-1/2" Aluminum Dial Case only)</b>
<b>T</b>	Oxygen Cleaning
<b>U</b>	Stainless Steel Tag with S.S. Wire
<b>V</b>	Stainless Steel Tag and S.S. Screw
<b>W</b>	Wall Mount Kit
<b>Z</b>	Special <b>(Un-coded Options)</b>
<b>NOTE: Not All Options Available in Combination with other Options</b>	
7	Electrical Configurations (CE marked, except N & P) Switch option not available for 130-PC Models
<b>H</b>	One (1) Reed Switch with Condulet Enclosure
<b>I</b>	Two (1) Reed Switches with Condulet Enclosure
<b>J</b>	One (1) Reed Switch with Condulet Enclosure with Plug-in connector (DIN 43650/IP65-PG11)
<b>K</b>	Two (1) Reed Switches with Condulet Enclosure with Plug-in connector (DIN 43650/IP65-PG11)
<b>L</b>	One (1) Switch in NEMA 4X Plastic Enclosure
<b>M</b>	Two (2) Switches in NEMA 4X Plastic Enclosure
<b>N</b>	One (1) Switch in explosion proof enclosure with glass window cover. CSA & UL Listed (1)
<b>P</b>	Two (2) Switches in explosion proof enclosure with glass window cover. CSA & UL Listed (1)
<b>Z</b>	Special <b>(Un-coded Options)</b>
(1) Complete assembly 3rd Party Certified Class I, Div.1, Groups C & D; Class II, Div. 1, Groups E, F, & G.	
8	Electrical Specifications (For Resistive Loads)
<b>A</b>	SPDT 3W, 0.25 Amp, 125 VAC/VDC <b>(Standard)</b> (Switch adjustable range of 10-90%)
<b>Z</b>	Special <b>(Un-coded Options)</b>
<b>NOTE:</b> The use of diaphragm seals is not recommended for Model 130 gauges	
<b>WARNING:</b> Attempts to install such seals on Model 130 gauges will void warranty	

**MID-WEST INSTRUMENT** has been serving a variety of industries (Power, Chemical, Petro-Chemical, HVAC, Water Filtration etc...) for over 50 years. Over 1,000,000 DP Gauges have been produced bearing the Mid-West name or private branded for our OEM customers!

Mid-West understands that in today's demanding environment, flexibility, quick response time and the ability to ship most of our product line in 2 weeks or less is essential to our customers. Standard configurations can be customized and modified to suit our customer's needs for ease of installation or retrofit.

If you are in need of additional information please visit our web site at [www.midwestinstrument.com](http://www.midwestinstrument.com) or contact us toll free at **1-800-648-5778** and one of our knowledgeable sales coordinators will be happy to assist you.



# Mid-West<sup>®</sup> Instrument

## “Diaphragm Type”

### Differential Pressure Gauges for Ammonia Service Application

*When it comes to tough application solutions Mid-West Instrument provides the answer!!*



Model 130  
Range 0-5" H2O

The Use of Differential Pressure gauges for Ammonia service in PowerGen emission control is a critical application. The use of special materials along with over 7 years of ammonia service experience has enabled our customers to have confidence that we provide a quality gauge that works not only at start up but for years to come in this harsh environment. Mid-West Instrument has optimized the internal wetted parts as well as the external parts to hold up to the rigors of this environment. We have optimized the design to improve removal of condensate from the system. Neoprene and Ethylene Propylene elastomers are highly recommended in Ammonia service especially at elevated temperatures.

**Model 130** Polysulfone or Stainless Steel is ideally suited for Ammonia service applications. Magnetic coupling between the sensing element and the indicating pointer provides for complete isolation of the process fluid within the pressure capsule. The Model 130 also has Over-range protection to full rated working pressure.

Model	Accuracy	Min. ΔP Range	Max. ΔP Range	Safe Working Pressure PSIG (Bar)	Optional Switches
130	±3/2/3% or *5%	0-5" H2O (0-12.4 mbar)	0-400" H2O (0-1 bar)	*300 (20) **500 (34)	1 or 2
* ±5% Range 0-5" to 0-9.9" H2O			* PolySulfone Engineered Plastic **Stainless Steel		
<b>(Optional Switches available on Stainless Steel body only.)</b>					
<b>Body Materials</b>		Glass Reinforced Polysulfone Engineered Plastic or 316 Stainless steel			
<b>Seal &amp; Diaphragm (under 20" H2O)</b>		Neoprene Diaphragm & Seals			
<b>Seal &amp; Diaphragm (over 20" H2O)</b>		Ethylene Propylene Diaphragm & Seals			
<b>Wetted Parts</b>		Body material & 316L Stainless Steel internal metal parts			
<b>Process Connections</b>		1/4" FNPT S.S. Adapters (Polysulfone Body)			
<b>Process Connections</b>		1/2" FNPT S.S. Adapters (316 Stainless Steel Body)			
<b>Mounting</b>		Panel Mount (Std.) Pipe Mount Optional			
<b>Lens</b>		Shatter Resistant Acrylic			
<b>Gauge Front</b>		4-1/2" Engineered Plastic (Ammonia Service Tested)			
<b>Temperature Limits</b>		-40°F to +200°F			

Contact Mid-West at 1-800-648-5778 for assistance with your Ammonia Service application.

# **SCR Post-Combustion NOx Control Model 130-PC or 130-SC**

Nitrogen oxides (NOx) are a combustion by-product of fossil fuels burned to produce energy. NOx emissions are regulated under the Clean Air Act.

A Selective Catalytic Reduction System (SCR) is a post combustion technology used to reduce NOx emissions. Ammonia (NH3) is injected into the flue gas. This mixture flows through a catalyst bed where the NH3 and the NOx react to form nitrogen and water vapor.

Aqueous or anhydrous ammonia is pumped from a tank and sprayed into a vaporizer where it is heated and mixed with air. The ammonia-air mixture flows through a distribution manifold system into an injection grid. The injection grid distributes the mixture into the flue gas stream.

The amount of ammonia is adjusted to produce the desired degree of reaction with the NOx. Mid-West Instrument model 130-PC or 130-SC are used to balance the flow of the ammonia-air mixture throughout distribution manifold system. The model 130-PC or 130-SC are also used to monitor an ammonia filter prior to injection into the vaporizer.

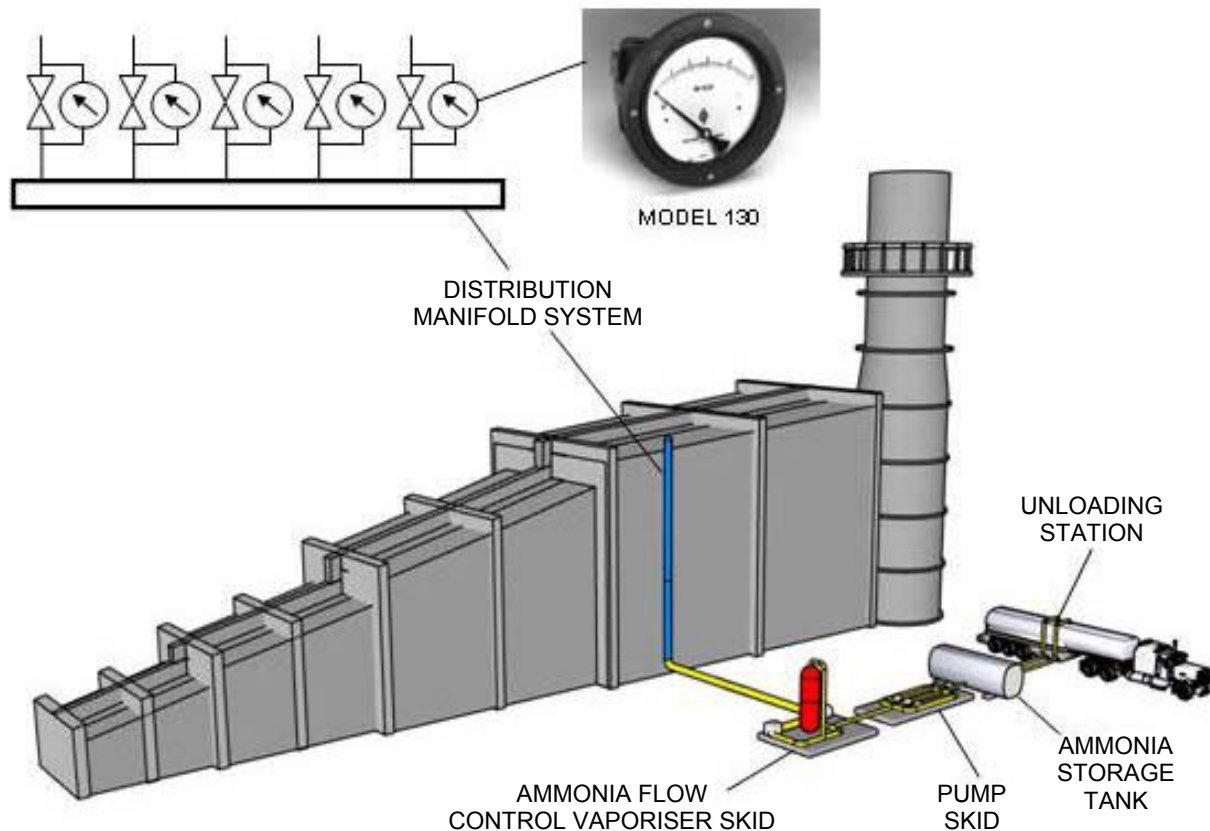

## **The list below represents just a few Model 130 Ammonia Service Gauge Customers**

Deltak, Big River Electric Corp, Express Integrated Technologies, Peerless Mfg  
Georgia Power, Ozonia North America, Marathon Petroleum, Hopkins Power Plant  
Black Hills Generation, Conoco Philips, Alstom Power, TVA, Mid-American Power  
Excel Energy, Babcock & Wilcox, Southern Company, Notre, Wahlco, Black & Vetch

# Mid-West<sup>®</sup> Instrument

## “Diaphragm Type” Differential Pressure Gauges Switches & Transmitters Model 140

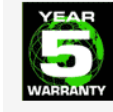

Model 140 Diaphragm type DP Gauge provides outstanding capabilities not previously available in a modestly priced differential pressure gauge/switch.

**Common Applications:** Filter/Strainer Monitoring, Compressed Air, Hydraulic, Refrigerant, Pump Performance Testing, Heat Exchanger Pressure Drop Monitoring, Water Treatment Applications, Tank Level Monitoring Horizontal or Vertical, Flow Monitoring & Balancing

Ideally suited for use on dissimilar fluids and wet gas or fluids with a high concentration of solids, etc.

Model 140 0-30 PSID  
with 2-1/2" Dial



*“A World Leader  
in Differential Pressure Gauges,  
Switches & Transmitters*

**Features:**

- Total separation of high and low pressures by a Convuluted Elastomer Diaphragm.
- Over range protection to full rated working pressure.
- Body Materials: Aluminum, Brass or 316L stainless steel Hasteloy available upon request.
- Internal metal parts 316 stainless steel.
- 1/4" FNPT & 1/2" FNPT Process Connections
- Sensor magnetically coupled to the indicating pointer and optional switches.
- Weather-resistant construction standard.
- Shatter resistant acrylic lens.
- Variety of Dial type and Sizes: 2-1/2", 3-1/2" & 4-1/2"
- DP Ranges available in: Inches H2O, PSID, bar, and Kpa
- Available with Square Root dials for flow measurement
- Multiple mounting options available
- Temperature Limits: -40°F(-40°C) to +200°F(+93°C)



Model 140 0-40 PSID & 0-2.8 Bar  
with 4-1/2" Dial & maximum follower pointer



Model 140 0-30 PSID & 0-200 kPa  
with 2-1/2" Dial & Special Color Dial

Model	Accuracy	Min. ΔP Range	Max. ΔP Range	Max. Line Pressure PSIG (bar)	Optional Switches
140	±5% 0-50" H2O to 0-399" H2O ±3/2/3% 0-15 PSID to 0-100 PSID	0-50" H2O (0-125 mbar bar)	0-100 PSID (0-7 bar)	3000 (200)**	1 or 2 Switches or 4-20 mA Transmitter

\*\* Brass Body Working Pressure rated @ 1500 PSIG (103 bar)

# “Diaphragm Type” Differential Pressure Gauge Switch & Transmitter Options Models: 140 & 142



**Model 140 shown with “AA” switch option**

(1) Reed switch located inside NEMA 4x enclosure with 7 position terminal strip. An opening at rear of enclosure accepts ½” flexible weather-proof or conduit connector (supplied by customer).

**Model 140 shown with “EA” switch option.**

(1) Reed switch in general purpose enclosure Division 2 Hazardous locations with 7 position terminal strip. An opening at rear of enclosure accepts ½” flexible weather-proof or conduit connector (supplied by customer).

**Model 140 & 142 “Delta Meters”** are available with either one or two hermetically sealed reed switches for either high alarm, low alarm, or both and a 4-20mA transmitter depending on model. The switches are Single Pole Double Throw (SPDT) or Single Pole Single Throw (SPST) with adjustable set points. Switches can be set to activate/deactivate on rising or falling pressure.

**Model 140& 142** standard switch enclosure is non-corrosive molded plastic that is oil tight, dust tight, and water tight per NEMA 4X. External access to the switch adjustment is provided. 3rd party certified Explosion Proof enclosures with SPDT or SPST switches rated Class I, Groups C & D, Class II, Groups E, F, & G are available. Switch leads are 24”, 18 Awg, and are color coded where applicable.



**Model 142 shown with “BA” switch option**

(2) Reed switches located inside NEMA 4x enclosure with 7 position terminal strip. An opening at rear of enclosure accepts ½” flexible weather-proof or conduit connector (supplied by customer).

Model Type	140, 142 SPDT	140 SPST NO	142 SPST NO	140, 142 Transmitter 4-20mA
Power	3 W	25 W	25 W	4-20 mA Loop Power
Max Current	0.25 Amps	0.5 Amps	0.5 Amps	8-28 VDC Loop Powered 2-Wire interface
Max Voltage VAC/VDC	125 VAC/VDC	230 VAC/VDC	230 VAC/VDC	1000 Ohm max Loop resistance at 28 vdc
Setting Full Scale	“140” 15-90% “142” 15-95%	15-90%	15-95%	20-100%
Hysteresis (Max / Norm)	10% / 5% (FS)	15% / 8% (FS)	15% / 8% (FS)	N/A
Repeatability	1% F.S.	1% F.S.	1% F.S.	1% F.S.
Connections	(3) 24" Leads 22 AWG	(2) 24" Leads 22 AWG	(2) 24" Leads 22 AWG	Terminal Strip





## Standard Model Specifications: 140-AA-00-00

3000 PSIG Working Pressure, Aluminum body, 316L Stainless Steel Internal Metal Parts,  
Ceramic Magnets, Buna-N Diaphragm and Seals, Teflon Guide Bushings, 1/4" FNPT Back Connections,  
2-1/2" round dial, Engineered Plastic Case with Shatter Resistant Acrylic Lens

0-50" H2O to 0-399" H2O Accuracy ±5% F.S. (Ascending)

**Mid-West Instrument** 0-15 PSID to 0-100 PSID Accuracy ±3/2/3% F.S (Ascending)

**1-800-648-5778**

**Range 0-50" H2O to 0-100 PSID (0-125 mbar to 0-7.0 bar)**

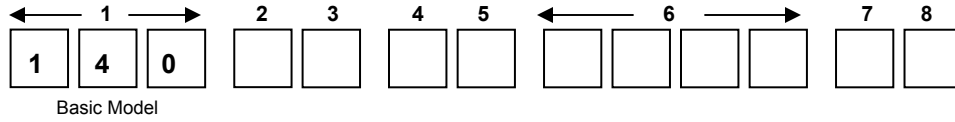

Range: \_\_\_\_\_



2	Material
<b>A</b>	Aluminum Body / 316 Stainless Steel Internal Metal Parts & Teflon Guide Bushings
<b>B</b>	Brass Body / 316 Stainless Steel Internal Metal Parts & Teflon Guide Bushings
<b>S</b>	316 Stainless Steel Body / 316 Stainless Steel Internal Metal Parts & Teflon Guide Bushings
<b>Z</b>	Special ( <b>Un-coded Options</b> )
3	Dial Size & Type
<b>A</b>	2-1/2" Round Uni-Directional Dial w/Engineered Plastic Housing Assembly
<b>C</b>	4-1/2" Round Uni-Directional Dial w/Engineered Plastic Housing Assembly
<b>E</b>	3-1/2" Round Uni-Directional Dial w/Anodized Aluminum Housing Dial Case
<b>G</b>	4-1/2" Round Uni-Directional Dial w/Anodized Aluminum Housing Dial Case
<b>T</b>	Non-Indicating DP Switch Only
<b>Z</b>	Special ( <b>Un-coded Options</b> )
4	Seal Materials
<b>0</b>	Buna-N ( <b>Standard</b> )
<b>1</b>	Viton®-A Registered Trademark of Dupont
<b>2</b>	Silicone
<b>5</b>	Ethylene Propylene
<b>9</b>	Special ( <b>Un-coded Options</b> )
5	Process Connections
<b>0</b>	1/4" FNPT Back Connections ( <b>Standard</b> )
<b>2</b>	Dual 1/4" FNPT Top & Bottom Connections ( <b>Non-Electrical Option Units Only</b> )
<b>3</b>	1/4" FNPT Bottom Connections
<b>4</b>	7/16"-20 straight thread O-Ring ( <b>Back Connections only</b> )
<b>7</b>	1/2" FNPT End Connections ( <b>2000 PSIG SWP for S.S. &amp; Alm. Gauge Body</b> ) (not available with C & D switch options)
<b>8</b>	1/4" FNPT End Connections ( <b>2000 PSIG SWP for S.S. &amp; Alm. Gauge Body</b> ) (not available with C & D switch options)
<b>9</b>	Special ( <b>Un-coded Options</b> )

## Standard Model Specifications – continued Model 140

6	Additional Options
O	None
A	Reversed High / Low Process Connections. (Not available with electrical options C, D, T & W)
E	Two (2) 1/4-20 Mounting Holes
F	Carbon Steel 2" Pipe Mounting Kit (Not available with reversed port switch option)
G	Stainless Steel 2" Pipe Mounting Kit (Not available with reversed port switch option)
K	1/2" FNPT Stainless Steel Adapters (Not available with end connections)
L	Liquid Fill (4-1/2" available with "G" option Aluminum Dial Case only) (not available with shatterproof lens)
M	Maximum Indicator Follower Pointer (not available with Liquid fill option) (not available with shatterproof lens)
N	NACE (Available for Aluminum & Stainless Steel Gauge Bodies only)
Q	CRN (Canadian Registration Number) Aluminum or S.S. Body only (2,000 PSIG SWP for Aluminum Body)
S	Shatter Proof Glass Lens (Available only with option "G" 4-1/2" Aluminum Dial Case) (not available with liquid fill)
T	Oxygen Cleaning
U	Stainless Steel Tag with S.S. Wire
V	Stainless Steel Tag and S.S. Screw (Contact factory on switch options)
W	Wall Mount Kit
X	Chemical Seals (Contact Factory for Accuracy)
Z	Special ( <i>Un-coded Options</i> )
<b>NOTE: Not All Options Available in Combination with other Options</b>	
7	Electrical Configurations (CE marked, except C, D, T & W)
O	None
A	One (1) Reed Switch in NEMA 4X/IP66 Enclosure
B	Two (2) Reed Switches in NEMA 4X/IP66 Enclosure
C	One (1) Switch in Explosion Proof Enclosure. Division 1 Hazardous Locations (1)
D	One (2) Switches in Explosion Proof Enclosure. Division 1 Hazardous Locations (1)
E	One (1) Reed Switch in NEMA 4X/IP66 Aluminum Enclosure, Division 2 Hazardous Locations (2)(3)
F	Two (2) Reed Switches in NEMA 4X/IP66 Aluminum Enclosure, Division 2 Hazardous Locations (2)(3)
T	4-20 mA Transmitter in NEMA-4X/IP66 aluminum enclosure
W	4-20 mA Transmitter in general purpose enclosure, Division 2 Hazardous Locations (2)(3)(4)
Z	Special ( <i>Un-coded Options</i> )
(1) Complete assembly 3rd Party Certified Class I, Div.1, Groups C & D; Class II, Div. 1, Groups E, F, & G.	
(2) Complete assembly 3rd Party Certified Class I, Div.2, Groups A, B, C, & D; Class II, Div.2, Groups F and G.	
(3) 1625 PSI SWP for NACE in combination with E, F and W electrical configuration	
(4) Contact factory for tank level or flow applications with transmitter configuration	
8	Electrical Specifications (For Resistive Loads)
O	None
A	SPDT 3W, 0.25 Amp, 125 VAC/VDC (standard) (Switch adjustable range of 15-90%)
B	SPST, 25W, 0.5 Amp., 230 VAC/VDC (Normally Open) (Switch adjustable range of 15-90%)
T	4-20 mA Transmitter (8-28 VDC Loop Power) (± 2% Accuracy from 20-100% of scale, Ascending)
Z	Special ( <i>Un-coded Options</i> )

Factory preset switches at no charge (Specify Setting)

**MID-WEST INSTRUMENT** has been serving a variety of industries (Power, Chemical, Petro-Chemical, HVAC, Water Filtration etc...) for over 50 years. Over 1,000,000 DP Gauges have been produced bearing the Mid-West name or private branded for our OEM customers!

Mid-West understands that in today's demanding environment, flexibility, quick response time and the ability to ship most of our product line in 2 weeks or less is essential to our customers. Standard configurations can be customized and modified to suit our customer's needs for ease of installation or retrofit.

If you are in need of additional information please visit our web site at [www.midwestinstrument.com](http://www.midwestinstrument.com) or contact us toll free at **1-800-648-5778** and one of our knowledgeable sales coordinators will be happy to assist you.



# Mid-West<sup>®</sup> Instrument

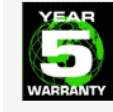

## “Diaphragm Type” Differential Pressure Gauges Switches & Transmitters Model 142

Model 142 Diaphragm type DP Gauge provides outstanding capabilities not previously available in a modestly priced differential pressure gauge/switch.

**Common Applications:** Filter/Strainer Monitoring, Compressed Air, Hydraulic, Refrigerant, Pump Performance Testing, Heat Exchanger Pressure Drop Monitoring, Water Treatment Applications, Tank Level Monitoring Horizontal or Vertical, Flow Monitoring & Balancing

Ideally suited for use on dissimilar fluids and wet gas or fluids with a high concentration of solids, etc.

Model 142 0-20" H<sub>2</sub>O  
with 2-1/2" Dial



**Features:**

- Total separation of high and low pressures by a Convuluted Elastomer Diaphragm.
- Over range protection to full rated working pressure.
- Body Materials: Aluminum, Brass or 316L stainless steel Hasteloy available upon request.
- Internal metal parts 316 stainless steel.
- 1/4" FNPT & 1/2" FNPT Process Connections
- Sensor magnetically coupled to the indicating pointer and optional switches.
- Weather-resistant construction standard.
- Shatter resistant acrylic lens.
- Variety of Dial type and Sizes: 2-1/2", 3-1/2" & 4-1/2"
- DP Ranges available in: Inches H<sub>2</sub>O, PSID, bar, and Kpa
- Available with Square Root dials for flow measurement
- Multiple mounting options available
- Temperature Limits: -40°F(-40°C) to +200°F(+93°C)

*“A World Leader  
in Differential Pressure Gauges,  
Switches & Transmitters*



Model 142  
with 2-1/2" Dial  
& 4-20mA Transmitter



Model 142 0-100" H<sub>2</sub>O  
with 4-1/2" Dial

Model	Accuracy	Min. ΔP Range	Max. ΔP Range	Max. Line Pressure PSIG (bar)	Optional Switches
142	±3/2/3%	0-20" H <sub>2</sub> O (0-50 mbar)	0-25 PSID (0-1.7 bar)	3000 (200)**	1 or 2 Switches or 4-20 mA Transmitter

\*\* Brass Body Working Pressure rated @ 1500 PSIG (103 bar)

# “Diaphragm Type” Differential Pressure Gauge Switch & Transmitter Options Models: 140 & 142



**Model 142 shown with “BA” switch option**

(2) Reed switches located inside NEMA 4x enclosure with 7 position terminal strip. An opening at rear of enclosure accepts ½” flexible weather-proof or conduit connector (supplied by customer).

**Model 140 shown with “AA” switch option**

(1) Reed switch located inside NEMA 4x enclosure with 7 position terminal strip. An opening at rear of enclosure accepts ½” flexible weather-proof or conduit connector (supplied by customer).

**Model 140 & 142 “Delta Meters”** are available with either one or two hermetically sealed reed switches for either high alarm, low alarm, or both and a 4-20mA transmitter depending on model. The switches are Single Pole Double Throw (SPDT) or Single Pole Single Throw (SPST) with adjustable set points. Switches can be set to activate/deactivate on rising or falling pressure.

**Model 140& 142** standard switch enclosure is non-corrosive molded plastic that is oil tight, dust tight, and water tight per NEMA 4X. External access to the switch adjustment is provided. 3rd party certified Explosion Proof enclosures with SPDT or SPST switches rated Class I, Groups C & D, Class II, Groups E, F, & G are available. Switch leads are 24”, 18 Awg, and are color coded where applicable.



**Model 140 shown with “EA” switch option.**

(1) Reed switch in general purpose enclosure Division 2 Hazardous locations with 7 position terminal strip. An opening at rear of enclosure accepts ½” flexible weather-proof or conduit connector (supplied by customer).

Model Type	140, 142 SPDT	140 SPST NO	142 SPST NO	140, 142 Transmitter 4-20mA
Power	3 W	25 W	25 W	4-20 mA Loop Power
Max Current	0.25 Amps	0.5 Amps	0.5 Amps	8-28 VDC Loop Powered 2-Wire interface
Max Voltage VAC/VDC	125 VAC/VDC	230 VAC/VDC	230 VAC/VDC	1000 Ohm max Loop resistance at 28 vdc
Setting Full Scale	“140” 15-90% “142” 15-95%	15-90%	15-95%	20-100%
Hysteresis (Max / Norm)	10% / 5% (FS)	15% / 8% (FS)	15% / 8% (FS)	N/A
Repeatability	1% F.S.	1% F.S.	1% F.S.	1% F.S.
Connections	(3) 24” Leads 22 AWG	(2) 24” Leads 22 AWG	(2) 24” Leads 22 AWG	Terminal Strip



## Standard Model Specifications: 142-AA-00-00

3000 PSIG Working Pressure, Aluminum body, 316L Stainless Steel Internal Metal Parts, Ceramic Magnets, Buna-N Diaphragm and Seals, Teflon Guide Bushings, 1/4" FNPT Back Connections, 2-1/2" round dial, Engineered Plastic Case with Shatter Resistant Acrylic Lens  
Accuracy  $\pm 3/2/3\%$  Full Scale (Ascending)

**Mid-West Instrument**

**1-800-648-5778    Range 0-20" H<sub>2</sub>O to 0-25 PSID (0-50 mbar to 0-1.7 bar)**

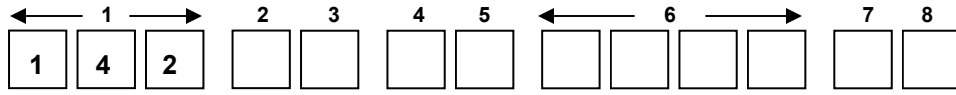

Basic Model

Range: \_\_\_\_\_



2	Material
A	Aluminum Body / 316 Stainless Steel Internal Metal Parts & Teflon Guide Bushings
B	Brass Body / 316 Stainless Steel Internal Metal Parts & Teflon Guide Bushings
S	316 Stainless Steel Body / 316 Stainless Steel Internal Metal Parts & Teflon Guide Bushings
Z	Special ( <b>Un-coded Options</b> )
3	Dial Size & Type
A	2-1/2" Round Uni-Directional Dial w/Engineered Plastic Housing Assembly
C	4-1/2" Round Uni-Directional Dial w/Engineered Plastic Housing Assembly
E	3-1/2" Round Uni-Directional Dial w/Anodized Aluminum Housing Dial Case
G	4-1/2" Round Uni-Directional Dial w/Anodized Aluminum Housing Dial Case
T	Non-Indicating DP Switch Only
Z	Special ( <b>Un-coded Options</b> )
4	Seal Materials
0	Buna-N ( <b>Standard</b> )
1	Viton®-A Registered Trademark of Dupont
5	Ethylene Propylene
9	Special ( <b>Un-coded Options</b> )
5	Process Connections
0	1/4" FNPT Back Connections ( <b>Standard</b> )
2	Dual 1/4" FNPT Top & Bottom Connections ( <b>Non-Electrical Option Units Only</b> )
3	1/4" FNPT Bottom Connections
4	7/16"-20 straight thread O-Ring ( <b>Back Connections only</b> )
7	1/2" FNPT End Connections ( <b>2000 PSIG SWP for S.S. &amp; Alm. Gauge Body</b> )
8	1/4" FNPT End Connections ( <b>2000 PSIG SWP for S.S. &amp; Alm. Gauge Body</b> )
9	Special ( <b>Un-coded Options</b> )

## Standard Model Specifications – continued Model 142

6	Additional Options
<b>O</b>	NONE
<b>A</b>	Reversed High / Low Process Connections. (Not available with transmitter options T & W)
<b>E</b>	Two (2) 1/4-20 Mounting Holes
<b>F</b>	Carbon Steel 2" Pipe Mounting Kit (Not available with reverse port switch option)
<b>G</b>	Stainless Steel 2" Pipe Mounting Kit (Not available with reverse port switch option)
<b>K</b>	1/2" FNPT Stainless Steel Adapters (Not available with end connections)
<b>L</b>	Liquid Fill (4-1/2" available with "G" option Aluminum Dial Case only) (not available with shatterproof lens)
<b>M</b>	Maximum Indicator Follower Pointer (not available with Liquid fill option) (not available with shatterproof lens)
<b>N</b>	NACE (Available for Aluminum & Stainless Steel Gauge Bodies only) (1500 PSIG SWP)
<b>Q</b>	CRN (Canadian Registration Number) (2)
<b>S</b>	Shatter Proof Glass Lens (Available only with option "G" 4-1/2" Aluminum Dial Case) (not available with liquid fill)
<b>T</b>	Oxygen Cleaning
<b>U</b>	Stainless Steel Tag with S.S. Wire
<b>V</b>	Stainless Steel Tag and S.S. Screw (Contact factory on switch options)
<b>W</b>	Wall Mount Kit (Not available with back connections)
<b>X</b>	Chemical Seals (Contact Factory for Accuracy)
<b>Z</b>	Special (Un-coded Options)
<b>NOTE: Not All Options Available in Combination with other Options</b>	
7	Electrical Configurations (CE marked, except T & W)
<b>A</b>	One (1) Reed Switch in NEMA 4X/IP66 Enclosure
<b>B</b>	Two (2) Reed Switches in NEMA 4X/IP66 Enclosure
<b>E</b>	One (1) Reed Switch in NEMA 4X/IP66 Aluminum Enclosure, Division 2 Hazardous Locations (1)(2)
<b>F</b>	Two (2) Reed Switches in NEMA 4X/IP66 Aluminum Enclosure, Division 2 Hazardous Locations (1)(2)
<b>T</b>	4-20 mA Transmitter in NEMA-4X/IP66 aluminum enclosure (3)
<b>W</b>	4-20 mA Transmitter in general purpose enclosure, Division 2 Hazardous Locations (1)(2)(3)
<b>Z</b>	Special (Un-coded Options)
(1) Complete assembly 3rd Party Certified Class I, Div.2, Groups A, B, C, & D; Class II, Div.2, Groups F and G.	
(2) 1375 PSIG SWP for CRN rating, and E, F & W Hazardous locations electrical configurations	
(3) Contact factory for tank level or flow applications with transmitter configuration	
8	Electrical Specifications (For Resistive Loads)
<b>A</b>	SPDT 3W, 0.25 Amp, 125 VAC/VDC (standard) (Switch adjustable range of 15-95%)
<b>B</b>	SPST, 25W, 0.5 Amp., 230 VAC/VDC (Normally Open) (Switch adjustable range of 15-95%)
<b>T</b>	4-20 mA Transmitter (8-28 VDC Loop Power) (± 2% Accuracy from 20-100% of scale, Ascending)
<b>Z</b>	Special (Unc-oded Options)

Factory preset switches at no charge (Specify Setting)

**MID-WEST INSTRUMENT** has been serving a variety of industries (Power, Chemical, Petro-Chemical, HVAC, Water Filtration etc...) for over 50 years. Over 2,000,000 DP Gauges have been produced bearing the Mid-West name or private branded for our OEM customers!

Mid-West understands that in today's demanding environment, flexibility, quick response time and the ability to ship most of our product line in 2 weeks or less is essential to our customers. Standard configurations can be customized and modified to suit our customer's needs for ease of installation or retrofit.

If you are in need of additional information please visit our web site at [www.midwestinstrument.com](http://www.midwestinstrument.com) or contact us toll free at **1-800-648-5778** and one of our knowledgeable sales coordinators will be happy to assist you.





# Mid-West<sup>®</sup> Instrument

## “Diaphragm Type”

### Differential Pressure Gauge, Switch, or Transmitter Model’s 140 & 142



## FOR SEA WATER APPLICATIONS

Ideally suited for use on Sea Water or salt Water applications.



Model 142  
with 2-1/2" Dial

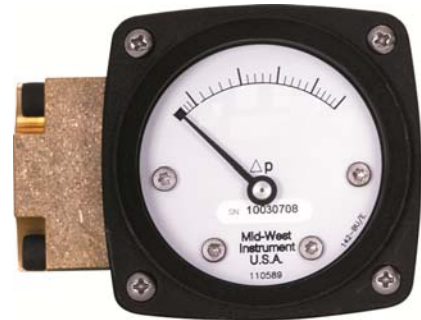

**Features:**

- Total separation of high and low pressures by a Convuluted Elastomer Diaphragm.
- Over range protection to full rated working pressure.
- Body Materials: Aluminum/Bronze, or Monel
- Monel Spring & Internal metal parts
- 1/4" FNPT FNPT Process Connection (std)
- Sensor magnetically coupled to the indicating pointer and optional switches.
- Weather-resistant construction standard.
- Shatter resistant acrylic lens.
- Variety of Dial type and Sizes: 2-1/2", 3-1/2" & 4-1/2"
- DP Ranges available in: Inches H<sub>2</sub>O, PSID, bar, and Kpa
- Temperature Limits: -40°F(-40°C) to +200°F(+93°C)

*“A World Leader  
in Differential Pressure Gauges,  
Switches & Transmitters*



Model 142  
with 2-1/2" Dial  
& 4-20mA Transmitter



Model 142 0-100" H<sub>2</sub>O  
with 4-1/2" Dial

Model	Accuracy	Available ΔP Ranges	Max. Line Pressure PSIG	Optional Switches
142 ±3/2/3%		0-100" H <sub>2</sub> O, 0-5 PSID, 0-10 PSID 0-15 PSID, 0-20 PSID	1000	1 or 2 Switches or 4-20 mA Transmitter
140	±3/2/3%	0-25 PSID, 0-30 PSID, 0-40 PSID 0-75 PSID, 0-100 PSID	1000	1 or 2 Switches or 4-20 mA Transmitter

# “Diaphragm Type” Differential Pressure Gauge Switch & Transmitter Options Model’s 140 & 142



**Model 142 available with “AA” switch option**

(1) Reed switch located inside NEMA 4x enclosure with 7 position terminal strip. An opening at rear of enclosure accepts ½” flexible weather-proof or conduit connector (supplied by customer).

**Model 142 available with “BA” switch option**

(2) Reed switches located inside NEMA 4x enclosure with 7 position terminal strip. An opening at rear of enclosure accepts ½” flexible weather-proof or conduit connector (supplied by customer).

**Model 142 “Delta Meters”** are available with either one or two hermetically sealed reed switches for either high alarm, low alarm, or both and a 4-20mA transmitter depending on model. The switches are Single Pole Double Throw (SPDT) or Single Pole Single Throw (SPST) with adjustable set points. Switches can be set to activate/deactivate on rising or falling pressure.

**Model 142** standard switch enclosure is non-corrosive molded plastic that is oil tight, dust tight, and water tight per NEMA 4X/IP66. External access to the switch adjustment is provided. 4-20 mA Transmitter enclosures is Aluminum that is oil tight, dust tight, and water tight per NEMA 4X/IP66 as well. An external zero pin is available for simple remote zeroing. Switch leads are 24”, 18 Awg, and are color coded where applicable.



**Model 142 shown with “TT” transmitter option.**

4-20 mA Transmitter in NEMA 4X/IP66 Aluminum Enclosure. 7 position terminal strip and opening at rear of enclosure accepts ½” flexible weather-proof or conduit connector (supplied by customer).

Model Type	142 SPDT	142 SPST NO	142 Transmitter 4-20mA
Power	3 W	25 W	4-20 mA Loop Power
Max Current	0.25 Amps	0.5 Amps	8-28 VDC Loop Powered 2-Wire interface
Max Voltage VAC/VDC	125 VAC/VDC	230 VAC/VDC	1000 Ohm max Loop resistance at 28 vdc
Setting Full Scale	15-95% 15-9	5%	20-100%
Hysteresis (Max / Norm)	10% / 5% (FS)	15% / 8% (FS)	N/A
Repeatability	1% F.S.	1% F.S.	1% F.S.
Connections	(3) 24" Leads 22 AWG	(2) 24" Leads 22 AWG	Terminal Strip

### Standard Model Specifications: 142-NA-00-00

1000 PSIG Working Pressure, Aluminum/Bronze body, Monel Internal Metal Parts,  
Ceramic Magnets, Buna-N Diaphragm and Seals, Teflon Guide Bushings, 1/4" FNPT Back Connections,  
2-1/2" round dial, Engineered Plastic Case with Shatter Resistant Acrylic Lens  
Accuracy  $\pm 3/2/3\%$  Full Scale (Ascending)

**Ranges Model 142: 0-100" H<sub>2</sub>O, 0-5, 0-10, 0-15, and 0-20 PSID**

**Ranges Model 140: 0-25, 0-30, 0-40, 0-75 and 0-100 PSID**

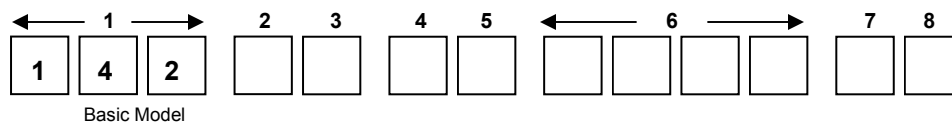

Basic Model

Range: \_\_\_\_\_

**Mid-West Instrument**  
1-800-648-5778



2	Material
<b>M</b>	Monel Body / Monel Internal Metal Parts & Teflon Guide Bushings
<b>N</b>	Aluminum/Bronze Body / Monel Internal Metal Parts & Teflon Guide Bushings
<b>Z</b>	Special ( <i>Un-coded Options</i> )
3	Dial Size & Type
<b>A</b>	2-1/2" Round Uni-Directional Dial w/Engineered Plastic Housing Assembly
<b>C</b>	4-1/2" Round Uni-Directional Dial w/Engineered Plastic Housing Assembly
<b>E</b>	3-1/2" Round Uni-Directional Dial w/Anodized Aluminum Housing Dial Case
<b>G</b>	4-1/2" Round Uni-Directional Dial w/Anodized Aluminum Housing Dial Case
<b>T</b>	Non-Indicating DP Switch Only
<b>Z</b>	Special ( <i>Un-coded Options</i> )
4	Seal Materials
<b>0</b>	Buna-N ( <i>Standard</i> )
<b>1</b>	Viton®-A Registered Trademark of Dupont
<b>5</b>	Ethylene Propylene
<b>9</b>	Special ( <i>Un-coded Options</i> )
5	Process Connections
<b>0</b>	1/4" FNPT Back Connections ( <i>Standard</i> )
<b>2</b>	Dual 1/4" FNPT Top & Bottom Connections ( <i>Non-Electrical Option Units Only</i> )
<b>3</b>	1/4" FNPT Bottom Connections
<b>4</b>	7/16"-20 straight thread O-Ring ( <i>Back Connections only</i> )
<b>9</b>	Special ( <i>Un-coded Options</i> )

## Standard Model Specifications – continued Model 142

6	Additional Options
<b>O</b>	NONE
<b>A</b>	Reversed High / Low Process Connections. <b>(Not available with transmitter options T)</b>
<b>E</b>	Two (2) 1/4-20 Mounting Holes
<b>F</b>	Carbon Steel 2" Pipe Mounting Kit <b>(Not available with reverse port switch option)</b>
<b>G</b>	Stainless Steel 2" Pipe Mounting Kit <b>(Not available with reverse port switch option)</b>
<b>L</b>	Liquid Fill <b>(4-1/2" available with "G" option Aluminum Dial Case only)</b> <b>(not available with shatterproof lens)</b>
<b>M</b>	Maximum Indicator Follower Pointer <b>(not available with Liquid fill option)</b> <b>(not available with shatterproof lens)</b>
<b>S</b>	Shatter Proof Glass Lens <b>(Available only with option "G" 4-1/2" Aluminum Dial Case)</b> <b>(not available with liquid fill)</b>
<b>T</b>	Oxygen Cleaning
<b>U</b>	Stainless Steel Tag with S.S. Wire
<b>V</b>	Stainless Steel Tag and S.S. Screw <b>(Contact factory on switch options)</b>
<b>W</b>	Wall Mount Kit <b>(Not available with back connections)</b>
<b>Z</b>	Special <b>(Un-coded Options)</b>
<b>NOTE: Not All Options Available in Combination with other Options</b>	
7	Electrical Configurations
<b>O</b>	None
<b>A</b>	One (1) Reed Switch in NEMA 4X/IP66 Enclosure
<b>B</b>	Two (2) Reed Switches in NEMA 4X/IP66 Enclosure
<b>T</b>	4-20 mA Transmitter in NEMA-4X/IP66 aluminum enclosure <b>(3)</b>
<b>Z</b>	Special <b>(Un-coded Options)</b>
<b>(3) Contact factory for tank level or flow applications with transmitter configuration</b>	
8	Electrical Specifications (For Resistive Loads)
<b>A</b>	SPDT 3W, 0.25 Amp, 125 VAC/VDC (standard) (Switch adjustable range of 15-95%)
<b>B</b>	SPST, 25W, 0.5 Amp., 230 VAC/VDC (Normally Open) (Switch adjustable range of 15-95%)
<b>T</b>	4-20 mA Transmitter (8-28 VDC Loop Power) ( $\pm$ 2% Accuracy from 20-100% of scale, Ascending)
<b>Z</b>	Special <b>(Unc-oded Options)</b>

Factory preset switches at no charge (Specify Setting)

**MID-WEST INSTRUMENT** has been serving a variety of industries (Power, Chemical, Petro-Chemical, HVAC, Water Filtration etc...) for over 50 years. Over 2,000,000 DP Gauges have been produced bearing the Mid-West name or private branded for our OEM customers!

Mid-West understands that in today's demanding environment, flexibility, quick response time and the ability to ship most of our product line in 2 weeks or less is essential to our customers. Standard configurations can be customized and modified to suit our customer's needs for ease of installation or retrofit.

If you are in need of additional information please visit our web site at [www.midwestinstrument.com](http://www.midwestinstrument.com) or contact us toll free at **1-800-648-5778** and one of our knowledgeable sales coordinators will be happy to assist you.

# Mid-West<sup>®</sup> Instrument

## “Diaphragm Type” Model 240

### “Hazardous Locations”

## Indicating / Non-Indicating Differential Pressure Switch or Transmitter



- A low cost Diaphragm type differential pressure switch for use in measuring or controlling the pressure drop cross filters, strainers, separators, valves and pumps.
- Working Pressure 1,500 PSIG (275 bar)
- Over-range protection to maximum pressure.
- Aluminum or 316 Stainless Steel wetted pressure containing body assembly.
- Wetted Internals – 316 Stainless Steel and Ceramic moving components.
- Weather resistant gauge construction standard.
- Dial Size: 4-1/2” with Shatter resistant acrylic lens.
- Five Year Limited Warranty

- Field wireable terminal strip interface.
- Up to 10A 120/240 VAC switching with DPDT Relay outputs.
- Hermetically Sealed Switch Outputs up to 3 Amps in SPST configuration and up to 1 Amp in SPDT configuration
- SPST outputs available in Normally Open or Normally Closed configurations
- Up to (2) independent adjustable switch points.
- 4-20 mA Transmitter with 8-28 Vdc loop power
- 1/2” Conduit interface
- CSA & UL Certified to US and Canadian standards.
- CSA & UL Certified:
  - Class I, Division 1 / Groups B, C & D
  - Class II, Division 1 / Groups E, F & G
  - Class I, Division 2 / Groups A, B, C & D
  - Class II, Division 2 / Groups F & G
- Certified for ATEX / IECEx
  - Ex d IIB + H2 Ex tb IIIC, IP65
  - Division 2 Units are NEMA 4X



Model	Body Material	Accuracy	Min. ΔP Range	Max. ΔP Range	MWP PSIG (Bar)	Switch Options
240	Aluminum & 316L S.S.	±3/2/3%	0-20” H2O (0-50 mbar bar)	0-100 PSID (0-7 bar)	1,500 (100)	1 or 2 switches or 4-20mA Transmitter

# “Diaphragm Type” Differential Pressure Gauge Switch Options Model 240

The switching components are housed under a copper free Aluminum cover the combination of the gauge body and the cover make up the flame-proof seal. Electrical interface to the internal field wire terminal strip is via ½” NPT industry standard conduit connection located through the gauge body.

The hazardous environment indicating differential pressure switch is available with one or two hermetically sealed reed switches with optional one or two DPDT relay outputs. Each switch is independently adjustable within a defined percentage of the full scale range of the gauge and is available in SPDT and SPST (normally open or normally closed) for various load power ratings. The switches can be set to activate or deactivate on rising or falling differential pressure. If the optional relay output is specified, an input operating voltage must also be specified.

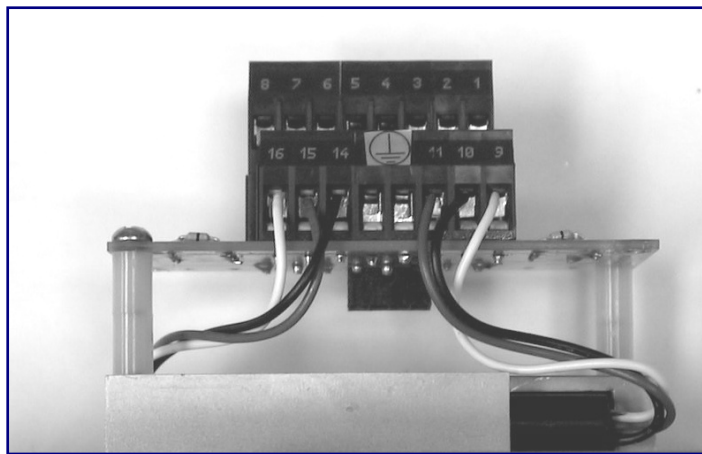

## OUTPUT RATINGS (Resistive Load)

Type	SPST	SPDT	SPDT	DPDT Relay
Electrical Specification Input Option	A	A	A	B,C,D,E,F,G,H
Electrical Specification Output Option	E	H	A	R
*Power	60 W	60 W	3W	N/A
Maximum Current	3 Amps	1.0 Amps	0.25 Amps	10 Amps
Max. Volts VAC/VDC	240	240	125	277 / 30
Setting (Full Scale) **	15% to 100%	25% to 100%	15%-100%	15% to 100%
Hysteresis Full Scale	20% / 9% (Max / Nom)	25% / 18% (Max / Nom)	15% / 6% (Max / Nom)	20% / 10% (Max / Nom)
Repeatability	1% Full Scale	1% Full Scale	1% Full Scale	1% Full Scale

\* Product of the switching voltage and current shall not exceed the power rating of device

\*\*For ranges ≥60 PSID, minimum adjustability = 25%

**Warning:** The suitability of the application and installation of this differential pressure switch is the responsibility of the end user. The applicable certifications, listings apply to the differential pressure switch only.

# “Diaphragm Type” Differential Pressure Gauge Transmitter Option Model 240

Model 240 Transmitter provides a simple low cost loop powered 8-28 Vdc two wire 4-20 mA transmitter with highly visible local display allowing for monitoring at the unit and in the control room.

The transmitter utilizes the same CSA, UL and ATEX rated sensor and explosion proof housing as on the Model 240 explosion proof switch. Although the transmitter option is not yet listed, the sensors and explosion proof housing are rated Class I, Division 1 Groups B, C & D. Class II, Division 1 Groups E, F & G and Ex d IIB + H2, Ex tb IIIC, IP65. Each transmitter is individually calibrated to the gauge using an 11 point calibration linearization technique.

<b>TRANSMITTER SPECIFICATIONS</b>				
<b>Transmitter Specifications: Comments:</b>				
Differential Pressure Range	0-20" H2O to 0-100 PSID			
Leakage	None, Diaphragm Isolated Hi to Lo			
Pressure (Ratings)				
Max Working	1500 PSIG			
Gauge Accuracy	2%	ASME B40.100 GRADE B		
Operating Temperature (Max.)	-20°F -150°F			
<b>ELECTRICAL:</b>				
	<b>Min</b>	<b>Typ</b>	<b>Max</b>	
Transmitter Accuracy (FSR)			2%	Upper 80% of Full Scale Range
Supply Voltage (3) (Vdc)	8		28	Pin 3 Reverse Polarity Protected
Output Current (ma)				
Zero Floating (2)	4.0 – 20.1 ma	4.0 – 21.0	4.0 – 22.0	Pin 2
Zeroed (1 connected to 2)		8		
Voltage (Pin 2 to 1)	4.8		6.3	
Zero Time (seconds)	2			
Max Loop Resistance (ohms)			1000	
Max Loop Resistance Formula	$((V_s - 8) / 20) * 1000$			
<b>INTERFACE:</b>				
<b>Electrical:</b>				
Connections:	4 Position Terminal Strip; ½" NPT Conduit 1= Rtn, 2= Zero, 3 = 8-28 Vdc In 4= Chassis			22 Awg – 12Awg Wire
Environmental Rating:	Explosion-proof Enclosure rated Class I, Div I, Groups B, C, D; Class II, Div I, Groups E, F, & G **			
Certifications:	Ex d IIB + H2 T6 (-30°C ≤ Ta ≤ 65°C)Gb Ex tb IIIC IP65 T85°C (-30°C ≤ Ta ≤ 65°C)Gd ATEX and IECEx			

**PROOF PRESSURE:** 3,000 PSI.

**TEMPERATURE LIMITS: -40°F (-40°C) to +185°F (+85°C)**– For electrical Input Options A in combination with electrical output options A, E, & H. These limits are based on the entire instrument being saturated to these temperatures. System (process) temperatures may exceed these limitations with proper installation. Contact our customer service representative for details.

**-40°F (-40°C) to +160°F (+70°C) – For output option R (Relay Output)**  
**-20°F (-30°C) to +150°F (+65°C) – For output option 4-20 mA Transmitter**

**STANDARDS:** The Model 240 Series differential pressure gauge either conforms to and/or is designed to the requirements of the following standards:

ASME B1.20.1	NEMA Std. No. 250
ASME B40.100 GRADE B	SAE J514
CSA-C22.2 No. 14, 25 and 30	EN60079-0, EN60079-1 & EN13463-1
UL Std. No. 50, 508, 698, and 1203	IEC60079-31





## Standard Model Specifications: 240-AC-02-O (JAA)

1500 PSIG Working Pressure, Aluminum wetted pressure containing body assembly, Stainless Steel/Ceramic Magnet Internals, Buna-N Seals, 1/4" FNPT End Connections, 4-1/2" round dial, engineered plastic dial case with Shatter Resistant Acrylic Lens, (1) 3W 125 VAC/VDC SPDT reed switch with terminal strip, aluminum explosion proof switch enclosure and 1/2" FNPT electrical access.

**Mid-West Instrument**

**Complete assembly 3<sup>rd</sup> Party Certified**

**1-800-648-5778**

**Range 0-20 IN. H<sub>2</sub>O to 0-100PSID (0-50 mbar to 0-7.0 bar)**

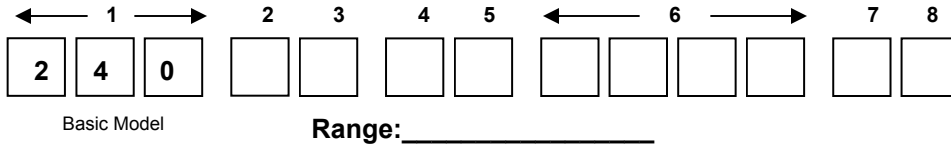

2	Material
A	Aluminum Wetted Pressure Containing Body, Stainless Steel / Ceramic Magnet Internals
	316/316L S.S Wetted Pressure Containing Body Assembly
S	Stainless Steel / Ceramic Magnet Internals
Z	Special ( <b>Un-coded Options</b> )
3	Dial Size & Type
C	4-1/2" Round Uni-Directional Dial w/Engineered Plastic Dial Case
F	4-1/2" Round Uni-Directional Dial w/Anodized Aluminum Housing Dial Case
T	Non-Indicating DP Switch Only (with select electrical options)
Z	Special ( <b>Un-coded Options</b> )
4	Seal Materials
0	Buna-N ( <b>Standard</b> )
1	Viton®-A Registered Trademark of Dupont
5	Ethylene Propylene
9	Special ( <b>Un-coded Options</b> )
5	Process Connections
2	1/4" FNPT End Connections ( <b>Standard</b> )
7	1/2" FNPT End Connections
9	Special ( <b>Un-coded Options</b> )
6	Additional Options
O	None
F	Carbon Steel 2" Pipe Mounting Kit
G	Stainless Steel 2" Pipe Mounting Kit
M	Maximum Indicator Follower Pointer ( <b>Not available with Electrical Configurations R &amp; S</b> )
Q	CRN ( <b>Canadian Registration Number</b> )
S	Shatter Proof Glass Lens ( <b>Available with 4-1/2" Aluminum Dial Case only</b> )
T	Oxygen Cleaning
U	Stainless Steel Tag with S.S. Wire
V	Stainless Steel Tag with S.S. Screw
Z	Special ( <b>Un-Coded Options</b> )

**NOTE: Not All Options Available in Combination with other Options**

## Standard Model Specifications – continued Model 240

"MODEL 240" ELECTRICAL CONFIGURATIONS	
<b>7</b>	<b>DP Ranges greater than or equal to 60 PSID the Switch adjustability is 25%-100% of Full Scale for all Switch options. (T6 Temperature Class unless specified)</b>
<b>A</b>	One (1) Control switch in NEMA-4X enclosure (1) (6) (8)
<b>B</b>	Two (2) Control switches in NEMA-4X enclosure (1) (6) (7) (8)
<b>J</b>	One (1) Control switch in NEMA 7 (Explosion Proof Enclosure) (2)
<b>K</b>	Two (2) Control switches in NEMA 7 (Explosion Proof Enclosure) (2) (7)
<b>R</b>	One (1) Control switch in Ex d Enclosure (CE marked) ATEX / IECEx (2) (9)
<b>S</b>	Two (2) Control switches in Ex d Enclosure (CE marked) ATEX / IECEx (2) (7) (9)
<b>T</b>	4-20 mA Transmitter in NEMA7/EEExd (Explosion Proof Enclosure) (9) (Temperature Limits -20°F to +150°F) Transmitter not yet CSA or UL certified
<b>Z</b>	Special ( <b>Un-coded Options</b> )
<b>8</b>	<b>"INPUT OPTIONS" ELECTRICAL SPECIFICATIONS (Select (1) input and (1) output option)</b>
<b>A</b>	No Input power for reed outputs A, E, F, G & H
<b>B</b>	5/6 VDC
<b>C</b>	12 VDC
<b>D</b>	24 VDC
<b>E</b>	48 VDC
<b>F</b>	24 VAC
<b>G</b>	120 VAC
<b>H</b>	240 VAC (T4-ATEX; T4A-NORTH AMER.) TEMP CLASS
<b>T</b>	8-28 Vdc Loop Power (Option T only)
<b>"OUTPUT OPTIONS" ELECTRICAL SPECIFICATIONS (Resistive Load) (3)</b>	
<b>A</b>	SPDT, 3W, 0.25 Amp., 125 VAC/VDC (Switch Adjustable 15-100% of full scale ascending) 60 PSID & Above 25-100% of full scale ascending
<b>E</b>	SPST, 60W, 3.0 Amp., 240 VAC/VDC (Normally Open) (Switch Adjustable 15-100% of full scale ascending)
<b>H</b>	SPDT, 60W, 1.0 Amp., 240 VAC/VDC (Switch Adjustable 25-100% of full scale ascending)
<b>R</b>	DPDT, Relay, 10A @ 30 VDC, 120/240 VAC (7) (8) (Switch Adjustable 15-100% of full scale ascending) 60 PSID & Above 25-100% of full scale ascending
<b>T</b>	4-20 mA Transmitter in general purpose enclosure, 3rd Party Certified Division 2 Hazardous Locations with Terminal Strip / 1/2" FNPT Conduit Connection ( $\pm 2\%$ accuracy from 20-100% of full scale ascending)
<b>Z</b>	Special (Contact Factory)
(1) Complete Assy. 3 <sup>rd</sup> Party Certified. Rated Class I, Div II, Groups A, B, C & D; Class II Div II Groups F&G (R output excluded)	
(2) Complete Assy. 3 <sup>rd</sup> Party Certified. Rated Class I, Div I, Groups B, C & D; Class II Div I Groups E, F&G	
(3) For output options A through H, the product switching voltage and current shall not exceed power rating.	
(6) Enclosure Type 4/4X	
(7) For electrical configuration B, K & S, SPDT relay output only	
(8) Electrical configuration A & B in combination with Output Option R is not rated for Hazardous Locations	
(9) Atex / IECEx Rated CE marked Ex d IIB + H <sub>2</sub> , Ex tb IIIC, IP65 (3000 PSIG SWP)	
(10) Not Available with Electrical Configurations R & S	

**MID-WEST INSTRUMENT** has been serving a variety of industries (Power, Chemical, Petro-Chemical, HVAC, Water Filtration etc...) for over 50 years. Over 1,000,000 DP Gauges have been produced bearing the Mid-West name or private branded for our OEM customers!

Mid-West understands that in today's demanding environment, flexibility, quick response time and the ability to ship most of our product line in 2 weeks or less is essential to our customers. Standard configurations can be customized and modified to suit our customer's needs for ease of installation or retrofit.

If you are in need of additional information please visit our web site at [www.midwestinstrument.com](http://www.midwestinstrument.com) or contact us toll free at **1-800-648-5778** and one of our knowledgeable sales coordinators will be happy to assist you.

# Mid-West<sup>®</sup> Instrument



## “Diaphragm Type” Model 522 Differential Pressure Gauge & Switch



Range: 0-5 PSID to 0-50 PSID

Available Dial Scales: PSID and Dual Scale PSID/kPa or PSID/bar



Model 522 Diaphragm Type DP Gauge provides outstanding capabilities in a modestly priced differential pressure gauge/switch.

Suited for use on dissimilar fluids, wet gas and process fluids with particulates present.

**Common Applications:** Filter/Strainer Monitoring, Compressed Air, Hydraulic, Refrigerant, Pump Performance Testing, Heat Exchanger Pressure Drop Monitoring, Water Treatment Applications.

### Gauge Features:

- Aluminum, 316 / 316L S.S. or Acetal Gauge Body.
- Wetted Parts: 316 SS, Ceramic, & Acetal components
- Seal & Diaphragm Material: Buna-N or Viton
- ALUM. & S.S. Bodies / Safe Working Pressure: 1000 PSIG
- Acetal Body / Safe Working Pressure: 500 PSIG
- 1/4" FNPT Process Connections (End Connected)
- Weather-resistant construction standard.
- 2-1/2" Diam. Black on White Dial (Std)  
(Dial Color Breaks Optional)
- Shatter Resistant Acrylic Lens
- **Optional:** (2)10-32 mounting holes on back of gauge body 1.75" apart x .330" Depth
- Accuracy  $\pm 5\%$  Full Scale (ascending)



Shown with special option color dial

**NOTE:** Reverse pressure should be avoided.

### Switch Option:

- Hermetically Sealed Switch
  - One (1) DIN 43650/IP65/NEMA 4X Plug-in Connector Switch\*\*
  - Output: 3 amps SPST, 60W, 240 VAC/VDC, Normally Open
  - Switch Adjustable from 40%-95% of Full Scale Range
  - CE Marked for Compliance with the Low Voltage Directive.
- \*\*Product of the switching voltage & current shall not exceed 60W



DIN  
Connector Shown

**Operation:** Differential pressure is sensed by flexible elastomer diaphragm and a calibrated spring. A magnetic coupling transmits the sensing element motion to an indicating pointer. This prohibits the possibility of fluid leaking into the gauge case, while assuring total isolation of the process fluid within the pressure capsule. The diaphragm assures total separation between high and low pressure signals.

**Temperature Limits:** -40 °F (-40° C) to 200°F (93°C). These limits are based on the entire instrument being saturated to these temperatures. System (process) temperatures may exceed these limitations with proper installation. Contact our customer service representative for details.

**Standards:** All Model 522 Series differential pressure gauges either conform to and/or are designed to the requirements of the following standards: ASME B1.20.1, ASME B40.100 NEMA Std. 250, EN-61010-1 UL Std. No. 50 & 508, CSA-C22.2 No. 14

Factory Preset of switch available at no charge (Specify switch setting on the order)

The use of diaphragm seals is not recommended.

Attempts to install such seals on this gauge will void the warranty

# Mid-West<sup>®</sup> Instrument

## Standard Dial Ranges: Model 522

Switch Set Point		Range	
Min Set Pt.	Max Set Pt.	PSID	DUAL SCALE
2 PSID	4.75 PSID	0-5 PSID	0-5 PSID & 0-0.35 bar
4 PSID	9.50 PSID	0-10 PSID	0-5 PSID & 0-35 kPa
6 PSID	14.25 PSID	0-15 PSID	0-10 PSID & 0-0.7 bar
8 PSID	19.00 PSID	0-20 PSID	0-10 PSID & 0-70 kPa
10 PSID	23.75 PSID	0-25 PSID	0-15 PSID & 0-1 bar
12 PSID	28.50 PSID	0-30 PSID	0-15 PSID & 0-100 kPa
16 PSID	38.00 PSID	0-40 PSID	0-20 PSID & 0-1.4 bar
20 PSID	47.50 PSID	0-50 PSID	0-20 PSID & 0-140 kPa
			0-25 PSID & 0-1.75 bar
			0-25 PSID & 0-175 kPa
			0-30 PSID & 0-2 bar
			0-30 PSID & 0-200 kPa
			0-40 PSID & 0-2.75 bar
			0-40 PSID & 0-275 kPa
			0-50 PSID & 0-3.5 bar
			0-50 PSID & 0-350 kPa

The above mentioned ranges are some of the most popular requested today. Mid-West Instrument can provide special un-cataloged dial range requirements. Multiple scale dials, multiple color dials and special decals are available upon request. Please consult factory for complete information.

Model	Min. ΔP Range	Max. ΔP Range
522	0-5 PSID (0-0.35 bar)	0-50 PSID (0-3.5 bar)

**Working Pressure:** 1000 PSI (69 bar) for Aluminum & Stainless Steel  
500 PSI (34.5 bar) for Acetal

**Proof Pressure:** 2000 PSI (138 bar) for Aluminum & Stainless Steel  
1000 PSI (69 bar) for Acetal

**Max Differential Pressure (Hi to Low)** 200 PSID (13.8 bar)

**Temperature Limits:** -40°F (-40°C) to +200°F (+93°C) - These limits are based on the entire instrument being saturated to these temperatures. System (process) temperatures may exceed these limitations with proper installation. Contact our customer service representative for details.

**Standards:** Model 522 Series gauge either conforms to and/or is designed to the requirements of the following standards:

ASME B1.20.1	ASME B40.1
NEMA Std. No. 250	CSA-C22.2 No. 14
EN-61010-1	UL Std. No. 50, 508

### Standard Model Specifications: 522-AA-02-00

1000 PSIG Working Pressure, Aluminum body, 316L Stainless Steel, Ceramic & Acetal Internal Parts  
 Buna-N Diaphragm and Seals, 1/4" FNPT End Connections  
 2-1/2" Round Black on White Dial w/ Engineered Plastic Case & Shatter Resistant Acrylic Lens  
 Accuracy ±5% Full Scale(Ascending)

**Mid-West Instrument**  
 1-800-648-5778

Range 0-5 PSID to 0-50 PSID (0.35 to 3.5 bar)

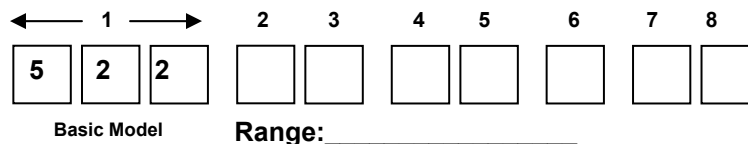

<b>2</b>	<b>Material</b>
<b>A</b>	Aluminum Body / 316 Stainless Steel, Ceramic & Acetal moving components
<b>S</b>	316 S.S. Body / 316 Stainless Steel, Ceramic & Acetal moving components
<b>P</b>	Acetal (Plastic) Body / 316 Stainless Steel, Ceramic & Acetal moving components
<b>3</b>	<b>Dial Size &amp; Type</b>
<b>A</b>	2-1/2" Round, Black on White Dial w/Engrd. Plastic Dial Case. <b>(Standard)</b>
<b>T</b>	Non-Indicating DP Switch Only
<b>4</b>	<b>Seal Materials</b>
<b>0</b>	Buna-N
<b>1</b>	Viton®-A Registered Trademark of Dupont
<b>5</b>	<b>Process Connections</b>
<b>2</b>	1/4" FNPT End Connections
<b>6</b>	<b>Options</b>
<b>O</b>	None
<b>A</b>	(2)10-32 Mounting Holes, Spaced 1.75" apart. x .330" Deep
<b>7</b>	<b>Electrical Configuration</b>
<b>O</b>	None
<b>L</b>	(1) Switch in Std. enclosure with plug-in connector (DIN43650/IP65) NEMA 4X Available with SPST 60W N.O. Electricals Only! Switch adj. 40 to 95% (F.S. Ascending)
<b>8</b>	<b>Electrical Specifications</b>
<b>E</b>	SPST 60W 3.0 Amp 240 VAC/VDC <b>(Normally Open)</b>

Factory Preset of switch available at no charge

Mid-West understands that in today's demanding environment, flexibility, quick response time and the ability to ship most of our product line in 2 weeks or less is essential to our customers. Standard configurations can be customized and modified to suit our customer's needs for ease of installation or retrofit.

If you are in need of additional information please visit our web site at [www.midwestinstrument.com](http://www.midwestinstrument.com) or contact us toll free at **1-800-648-5778** and one of our knowledgeable sales coordinators will be happy to assist you...



# Mid-West<sup>®</sup> Instrument

## “Diaphragm Type” Model 522



### Differential Pressure Gauge & Switch

Range: 0-5 PSID to 0-50 PSID



0-25 PSID

Colored bands allow you to quickly identify pressure drop across element.

Divided into three sections, each clearly marked for ease of understanding. Used to indicate critical pressure drops or when to change or clean a filter.

Suited for use in Air, Gas, Dissimilar fluids, Wet Gas and process fluids with particulates present.

#### Gauge Features:

- Aluminum, 316 / 316L Stainless Steel and Acetal/Plastic Gauge Bodies
- Wetted Parts: 316 SS, Ceramic, & Acetal components
- Seal & Diaphragm Material: Buna-N (Viton available upon request)
- Safe Working Pressure: 1000 PSIG
- ¼" FNPT Process Connections (End Connected)
- Weather-resistant construction standard.
- 2-1/2" and Engineered Plastic Dial w/ Shatter Resistant Acrylic Lens
- 3 Color Dial Scale.

Green Clean / Yellow Change / Red Dirty

- (2)10-32 mounting holes on back of gauge body  
1.75" apart x .330" Depth
- Accuracy  $\pm 5\%$  Full Scale (ascending)

**NOTE:** Reverse pressure should be avoided.

#### Switch Option:

- Hermetically Sealed Switch
- (1) DIN 43650/IP65-PG9 NEMA 4X Plug-in Connector Switch\*\*  
Compression plug accepts 4.5 to 7mm cable
- “LA” = Output: SPDT, 3W, 0.25 Amp, 125 VAC/VDC  
**Switch Adjustable from 25%-90% of Full Scale Range**
- “LE” = Output: SPST, 60W, 3 Amp, 240 VAC/VDC, Normally Open  
**Switch Adjustable from 40%-95% of Full Scale Range**
- CE and ROHS Marked for conformance with the Low Voltage Directive(73/23/EEC)

\*\*Product of the switching voltage & current shall not exceed 60W

Model 522 Series differential pressure gauge either conforms to/or are designed to the requirements of the following standards:

ASME B1.20.1, ASME B40.100  
NEMA Std. 250, EN-61010-1  
UL Std. No. 50 & 508, CSA-C22.2 No. 14



0-10 PSID



0-10 PSID with Switch



ALM. Model No.	Acetal Plastic Model No.	S.S. Model No.	PSID Range	Transition Points			ALM. Price Each	ACETAL Price Each	S.S. Price Each
				Green Clean	Yellow Change	Red Dirty			
<b>BUNA-N Seal &amp; Diaphragm</b>									
522A-005	522P-005	522S-005	0-5	0-3.0	3.0-4.0	4.0-5.0	\$122.50	\$138.00	\$148.00
522A-010	522P-010	522S-010	0-10	0-5.0	5.0-7.0	7.0-10.0	\$122.50	\$138.00	\$148.00
522A-015	522P-015	522S-015	0-15	0-7.5	7.5-11.0	11.0-15.0	\$122.50	\$138.00	\$148.00
522A-020	522P-020	522S-020	0-20	0-10	10.0-15.0	15.0-20.0	\$122.50	\$138.00	\$148.00
522A-025	522P-025	522S-025	0-25	0-11.0	11.0-18.5	18.5-25.0	\$122.50	\$138.00	\$148.00
522A-030	522P-030	522S-030	0-30	0-13.0	13.0-20.0	20.0-30.0	\$122.50	\$138.00	\$148.00
522A-050	522P-050	522S-050	0-50	0-20	20.0-30.0	30.0-50.0	\$122.50	\$138.00	\$148.00
<b>VITON Seal &amp; Diaphragm</b>									
522A-005V	522P-005V	522S-005V	0-5	0-3.0	3.0-4.0	4.0-5.0	\$125.00	\$140.00	\$150.00
522A-010V	522P-010V	522S-010V	0-10	0-5.0	5.0-7.0	7.0-10.0	\$125.00	\$140.00	\$150.00
522A-015V	522P-015V	522S-015V	0-15	0-7.5	7.5-11.0	11.0-15.0	\$125.00	\$140.00	\$150.00
522A-020V	522P-020V	522S-020V	0-20	0-10	10.0-15.0	15.0-20.0	\$125.00	\$140.00	\$150.00
522A-025V	522P-025V	522S-025V	0-25	0-11.0	11.0-18.5	18.5-25.0	\$125.00	\$140.00	\$150.00
522A-030V	522P-030V	522S-030V	0-30	0-13.0	13.0-20.0	20.0-30.0	\$125.00	\$140.00	\$150.00
522A-050V	522P-050V	522S-050V	0-50	0-20	20.0-30.0	30.0-50.0	\$125.00	\$140.00	\$150.00
<b>BUNA-N Seal &amp; Diaphragm with Switch</b>									
522A-005-LA	522P-005-LA	522S-005-LA	0-5	0-3.0	3.0-4.0	4.0-5.0	\$173.50	\$189.00	\$199.00
522A-005-LE	522P-005-LE	522S-005-LE							
522A-010-LA	522P-010-LA	522S-010-LA	0-10	0-5.0	5.0-7.0	7.0-10.0	\$173.50	\$189.00	\$199.00
522A-010-LE	522P-010-LE	522S-010-LE							
522A-015-LA	522P-015-LA	522S-015-LA	0-15	0-7.5	7.5-11.0	11.0-15.0	\$173.50	\$189.00	\$199.00
522A-015-LE	522P-015-LE	522S-015-LE							
522A-020-LA	522P-020-LA	522S-020-LA	0-20	0-10	10.0-15.0	15.0-20.0	\$173.50	\$189.00	\$199.00
522A-020-LE	522P-020-LE	522S-020-LE							
522A-025-LA	522P-025-LA	522S-025-LA	0-25	0-11.0	11.0-18.5	18.5-25.0	\$173.50	\$189.00	\$199.00
522A-025-LE	522P-025-LE	522S-025-LE							
522A-030-LA	522P-030-LA	522S-030-LA	0-30	0-13.0	13.0-20.0	20.0-30.0	\$173.50	\$189.00	\$199.00
522A-030-LE	522P-030-LE	522S-030-LE							
522A-050-LA	522P-050-LA	522S-050-LA	0-50	0-20	20.0-30.0	30.0-50.0	\$173.50	\$189.00	\$199.00
522A-050-LE	522P-050-LE	522S-050-LE							
<b>VITON Seal &amp; Diaphragm with Switch</b>									
522A-005V-LA	522P-005V-LA	522S-005V-LA	0-5	0-3.0	3.0-4.0	4.0-5.0	\$176.00	\$191.50	\$201.50
522A-005V-LE	522P-005V-LE	522S-005V-LE							
522A-010V-LA	522P-010V-LA	522S-010V-LA	0-10	0-5.0	5.0-7.0	7.0-10.0	\$176.00	\$191.50	\$201.50
522A-010V-LE	522P-010V-LE	522S-010V-LE							
522A-015V-LA	522P-015V-LA	522S-015V-LA	0-15	0-7.5	7.5-11.0	11.0-15.0	\$176.00	\$191.50	\$201.50
522A-015V-LE	522P-015V-LE	522S-015V-LE							
522A-020V-LA	522P-020V-LA	522S-020V-LA	0-20	0-10	10.0-15.0	15.0-20.0	\$176.00	\$191.50	\$201.50
522A-020V-LE	522P-020V-LE	522S-020V-LE							
522A-025V-LA	522P-025V-LA	522S-025V-LA	0-25	0-11.0	11.0-18.5	18.5-25.0	\$176.00	\$191.50	\$201.50
522A-025V-LE	522P-025V-LE	522S-025V-LE							
522A-030V-LA	522P-030V-LA	522S-030V-LA	0-30	0-13.0	13.0-20.0	20.0-30.0	\$176.00	\$191.50	\$201.50
522A-030V-LE	522P-030V-LE	522S-030V-LE							
522A-050V-LA	522P-050V-LA	522S-050V-LA	0-50	0-20	20.0-30.0	30.0-50.0	\$176.00	\$191.50	\$201.50
522A-050V-LE	522P-050V-LE	522S-050V-LE							

Factory Preset of switch available at no charge (Specify switch setting on the order)

**Operation:** Differential pressure is sensed by flexible elastomer diaphragm and a calibrated spring. A magnetic coupling transmits the sensing element motion to an indicating pointer. This prohibits the possibility of fluid leaking into the gauge case, while assuring total isolation of the process fluid within the pressure capsule. The diaphragm assures total separation between high and low pressure signals.

## Dimensional Drawings

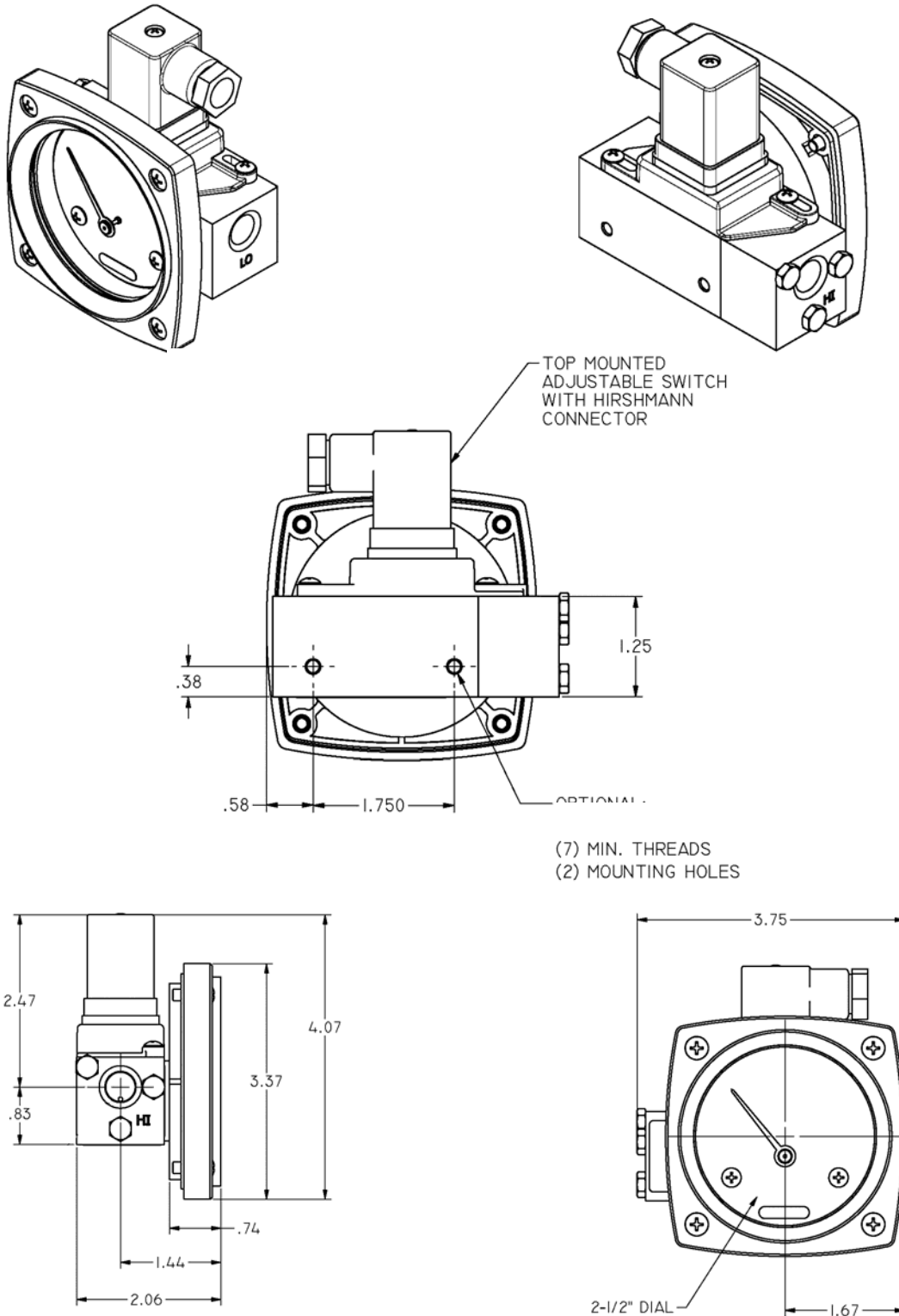

**Temperature Limits:** -40 °F (-40° C) to 200°F (93°C). These limits are based on the entire instrument being saturated to these temperatures. System (process) temperatures may exceed these limitations with proper installation. Contact our customer service representative for details.



# Mid-West<sup>®</sup> Instrument

## Differential Pressure Indicator Model 555A

Colored bands allow you to quickly identify pressure drop across element. Divided into three sections, each clearly marked for ease of understanding. Commonly used to indicate when to change or clean a filter.

**Example:** 555A-10.0 changes from green to yellow at 5 PSID and from yellow to red at 7.5 PSID.

Mounting block has 1/4" FNPT in-line process connections for ease of installation. Accuracy is ±5% Full Scale

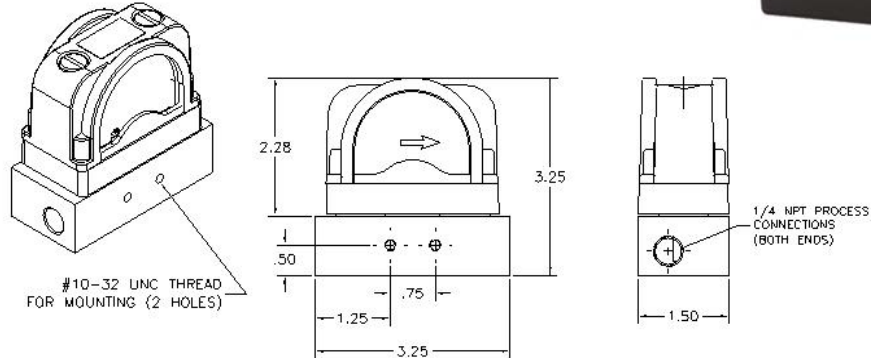

Model No. Buna-N	Model No. Viton	DP Range	Transition Points		
			Green	Yellow	Red
555A-3.5	555A-3.5V	0-3 PSID	0-2.0	2.0-2.5	2.5-3.5
555A-5.0	555A-5.0V	0-5 PSID	0-3.0	3.0-4.5	4.5-5.0
555A-10.0	555A-10.0V	0-10 PSID	0-5.0	5.0-7.5	7.5-10.0
555A-12.0	555A-12.0V	0-12 PSID	0-6.0	6.0-9.0	9.0-12.0
555A-15.0	555A-15.0V	0-15 PSID	0-7.5	7.5-12.0	12.0-15.0
555A-25.0	555A-25.0V	0-25 PSID	0-11.0	11.0-18.5	18.5-25.0
555A-30.0	555A-30.0V	0-30 PSID	0-13.0	13.0-20.0	20.0-30.0
555A-43.0	555A-43.0V	0-43 PSID	0-19.5	19.5-29.5	29.5-43.0

SPECIFICATIONS:			Comments:
Pressure (Ratings)			
Maximum Working	300 PSIG		
Maximum Differential	150 PSID		
Accuracy	± 5% of Rated Differential Pressure Range		Calibrated at Color Transitions
Operating Temperature (Max.)	93°C (200°F)		
Materials of Construction			
Body Material	Glass Filled Nylon (GFN)		
Wetted Internals	Stainless Steel, Ceramic, & GFN		
Elastomers	Buna-N or Viton		
Movement	Magnetic Piston and Follower Pointer		
Dial	Plastic Lens with 3 Color Dial		
INTERFACE:			
Process Connections:	1/4" FNPT End Connections. To switch HIGH and LOW pressure connections: (Remove Indicator from base and rotate 180° - Retighten plastic bolts to 20-25 inch pounds.)		Flow Direction Identified on Dial. (Arrow Points to Low Pressure Port)



# Mid-West<sup>®</sup> Instrument

## Differential Pressure Transmitter

Range 0-5 PSID (0- 0.35 Bar) thru 0-300 PSID (0-20 Bar)

Mid-West Instrument wet/wet differential pressure transmitter utilizes a piezoresistive differential pressure sensor sensing element with stainless steel isolated diaphragm. Silicon oil is filled in between die and two diaphragms. The measured differential pressure is transmitted onto the die through the diaphragm and silicon oil. The signal output generated by the piezoresistive bridge sensor is amplified into a useable voltage or 4-20 mA output as specified by customer. Series 700 is manufactured in China. 1 Year Limited Warranty. (Standard Delivery 4 Weeks ARO.)

### Product Features

- Use with Liquid or Gas media compatible with material of construction
- Full stainless steel construction, compact size, easy installation
- Laser welded, fully-sealed construction: NEMA 4X (IP65)
- Utilizes Piezoresistive Differential Pressure Sensor Isolated Diaphragm
- Zero and Span Adjustable
- CE Certified to EMI / EMC Directive
- LCD or LED display available upon request
- (Available with DIN Connector & 4-20mA Output Only)
- Maximum Overpressure (+) Hi-Side equals 2 times specified DP range
- Maximum Overpressure (-) Low-Side is equal to specified DP range
- Maximum Static Pressure 2,900 PSI

It is recommended to install a 3 valve manifold between point of measurement and the transmitter.

### Materials of Construction

- **Pressure Port & Housing:** 321 Stainless Steel
- **Diaphragm:** 316L Stainless Steel
- **O-ring:** Viton
- **Process Connections:** 1/4" Female BSPP (STD)
- **Fill liquid:** Silicon Oil

### Available Electrical Specifications:

- **Power Supply:** 2-Wire 15~28 VDC  
2-Wire 18~28 VDC, 2-Wire 20-28 VDC,  
3-Wire 15~28 VDC
- **Output Signals:** 2-Wire 4~20mADC,  
3-Wire, 0~5VDC, 1~5VDC, 0~5VDC  
0~10VDC, 0-10mADC and 0-20m ADC
- **Electrical Connections:**  
Din Plug 43650 or 1.5m 4-pin cable
- Response Time: (10%~90%) ≤1ms
- Insulation Resistance 100MΩ, 50VDC



LCD or LED  
3-1/2 Digit Display



1/4" BSPP x 1/4" FNPT  
1/4" BSPP x 1/2" FNPT  
S.S. Adapters Available

Description	Range	% / Unit	
Accuracy (LIN, HYS, & REP.)	5~300 PSID	0.50% Full Scale	
Zero Thermal Drift	0~15 PSID	±.03% Full Scale / °C Typ.	
	30~300 PSID	±.02% Full Scale / °C Typ.	
FS Thermal Drift	0~15 PSID	±.03% Full Scale / °C Typ.	
	30~300 PSID	±.02% Full Scale / °C Typ.	
Stability	< 30 PSI	0.50%	%FS / Year
	≤ 30 PSI	0.20%	
Static Pressure Effect	±0.05%	FS, ea. 15 PSI	
Compensation Temperature	0~50		
Operating Temperature	-10~80		
Storage Temperature	-40~120		
		°C	

**Standard Model Specification: 700-22-005P-C4-B1-E**

321 Stainless Steel Pressure Port & Housing, 316 Stainless Steel Diaphragm  
 Viton O'Rings, 1/4" Female BSPP Connections, DIN 43650/IP65 Plug-In Type Connector  
 Electrical Input & Output: 2-wire 15~28VDC / 4~20mADC  
 Accuracy ±0.5% Full Scale



**Mid-West Instrument**  
 1-800-648-5778

**Range: 0-5 PSID (0-0.35 Bar) to 0-300 PSID (0-20 Bar)**

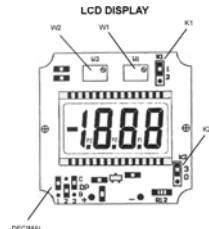
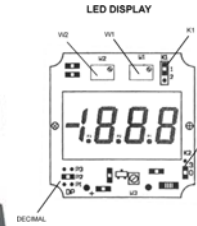
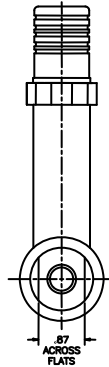
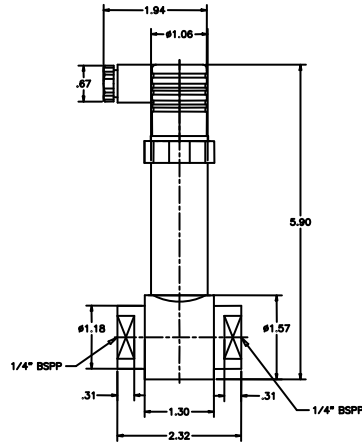
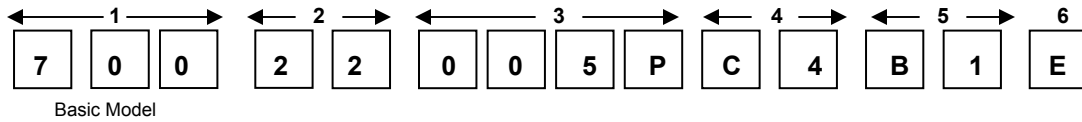

1	Description
700	Differential Pressure Transmitter
710	Differential Pressure Transmitter W/LCD Readout (Available with DIN Connector & 4-20mA Output only)
715	Differential Pressure Transmitter W/LED Readout (Available with DIN Connector & 4-20mA Output only)
2	Materials of Construction
22	Pressure Port & Housing = 321 S.S. / Diaphragm = 316L S.S.
3	Differential Pressure Range
PSID=P	5, 10, 15, 30, 50, 100, 150, & 300 PSID
Bar=B	.35, .70, 1, 2, 3.5, 7, 10, 20
kPa=K	35, 70, 100, 200, 350, 700
4	Process Connection
C4	1/4" Female BSPP (STD)
5	Electrical Connection
B1	DIN 43650/IP65 Plug-In Type
B2	Cable Connection / Standard Length 1.5m
6	Power Supply Input / Output Signal
E	2-wire 15~28VDC / 4~20mADC / LCD Display 18-28 VDC / LED Display 20-28VDC
F	3-wire 15~28VDC / 1~5VDC
J	3-wire 15~28VDC / 0~5VDC
Q	3-wire 15~28VDC / 0~10mADC
U	3-wire 15~28VDC / 0~20mADC
V	3-wire 15~28VDC / 0~10VDC
316 S.S. Adapters (includes Viton O'ring)	
113319	1/4" MALE BSPP to 1/4" FNPT 316 S.S. Adapter
113320	1/4" MALE BSPP to 1/2" FNPT 316 S.S. Adapter

# BELLOWS STYLE GAUGE

---



For Installation and Operation Manuals  
Please Visit: [www.midwestinstrument.com/literature](http://www.midwestinstrument.com/literature)

---

**Mid-West**  
Instrument





# Mid-West<sup>®</sup> Instrument

## “Bellows Type”

### Differential Pressure Gauges & Switches

### Model's 105 & 106



Dry Gauge Design with  
No Internal Liquid Fill



Over Range Protection high-low and  
low-high to rated working pressure  
with use of a bi-directional relief valve

**Model 105/106 DP Range:** 0-10" H<sub>2</sub>O to 0-30 PSID (25 mbar to 3.0 bar)

- Diaphragm Bellows design provides a simple, compact, accurate, direct-acting, low range high accuracy differential pressure indicator.
- Easier and less expensive to service/repair than competitive units.
- Working pressures of 500, 1500, 3000, or 6000 PSIG (400 bar).
- Housing materials: Aluminum, Brass, Carbon Steel, or 316L S.S.
- Internals: Stainless Steel Diaphragm Bellows.
- Available: Elastomers: Buna-N, Viton, Neoprene, Ethylene Propylene
- Mechanical over-range protection high to low and low to high.
- Weather resistant case of Engineered Plastic / Shatter resistant acrylic lens
- Panel Mounting Kit Standard
- Uni-directional or Bi-directional dials are readily available.
- Gauges are optionally available with one or two switches which offer's the ability to have alarm or control.



**Model's 105/106** ( $\pm 1/2\%$  or  $\pm 1\%$  Full Scale Accuracy) System pressure is applied to the internal volume of a bellows and mechanical linkage assembly. As pressure changes, the bellows and linkage assembly move to cause an electrical signal to be produced or to cause a gauge pointer to move. The major components are a two-piece body, multiple diaphragm/bellows sensing element and over-pressure assembly, a torque tube assembly, a range spring and the gauge front assembly. The body halves provide the pressure containment function. They also clamp the sensing element and over-pressure assembly between the halves, isolating the high side and low side pressures of the system. The high side body half also provides a mount for the torque tube assembly and the gauge front assembly.

Model	Accuracy	Min. $\Delta P$ Range	Max. $\Delta P$ Range	Safe Working Pressure PSIG (bar)	Optional Switches
105	$\pm 1/2\%$ or $1\%$	0-10" H <sub>2</sub> O (0-25 mbar)	0-79.9" H <sub>2</sub> O (0-200 mbar)	500-6000 (34-400)	1 or 2
106	$\pm 1/2\%$ or $1\%$	0-80" H <sub>2</sub> O (0-200 mbar)	0-800" H <sub>2</sub> O (0-30 PSID)	500-6000 (34-400)	1 or 2

**Model's 105/106** assembly incorporates a bi-directional relief valve which provides over-pressure protection in both directions. When over-pressured from the high side, the valve is opened by a mechanical stop as the sensing element deflects to its maximum travel. When over-pressured from the low side, the spring-loaded valve opens when the differential pressure exceeds its maximum rating. The opening of the valve in either direction equalizes the pressure and protects the unit. A range spring is provided to adjust the spring rate of the system to suit the various differential pressure ranges of the instrument.

# Mid-West<sup>®</sup> Instrument

## Models 105 & 106

“Bellows Type”

### Differential Pressure Switch Options



**LOCKED LOGIC™ SOLID STATE ALARM-CONTROL FOR ALL 105 & 106 GAUGES**

**SNAP ACTING MICRO-SWITCH** for MODEL 106 Range: 0-80" to 0-800" H2O.  
(NOTE SWITCH OPTIONS FOR 6" DIAL SIZE ONLY)

If your application requires switching in addition to local indication, our all solid state **"Locked Logic"** system is the most accurate available. With no moving cams, levers, etc. it does not affect the accuracy of the gauge on which it is installed. Switch accuracy is the same as the gauge accuracy. Visible set pointers are provided, adjustable to within 5% of full scale of each other. The set points are adjustable from 5 to 95% of full scale. Internal adjustment is standard. 1-2 Independently adjustable switches with Set Point Feedback, SPDT or DPDT Output options, Adjustable deadband option for single SPDT or DPDT output (2 set pointers) Accuracy of Gauge unaffected by the switch. Locked Logic switches require input power to operate.

Model 106 can also be equipped with one or two independently adjustable SPDT snap acting **Micro-Switches** which can be set on decreasing or on increasing pressure. A switch adjustment screw and a switch lock screw is accessible after removal of the lens and bezel (removal of 4 screws). Interface to the snap acting micro-switch is via color coded 18 AWG flying leads and a 1/2" FNPT conduit connection. Snap acting Micro switches do not require input power to operate.

**NOTE: Snap Acting Micro-Switches are not available with Bi-Directional Range Gauges**

**NOTE** : It is strongly recommended that a 3-Valve differential pressure manifold be used in plumbing your model 105/106 to your system. Properly used it should insure that your instrument is not over-ranged or damaged by pressure shocks during pressurization. It will later zeroing, ranging and calibration checking. It is a good practice to purge or flush the instrument loop prior to connecting the instrument.

OPTION	INTERFACE	MARKINGS	ENVIRONMENTAL	COMMENTS
A, B	1/2" FNPT Conduit with 24" LNG, 18 AWG Colored Flying Leads, 3/4" FNPT for (2) DPDT Outputs	NONE	Weather-proof Housing NEMA 4	Requires Input Power to Operate.
C, D	1/2" FNPT Conduit with 24" LNG, 18 AWG Colored Flying Leads, 3/4" FNPT for (2) DPDT Outputs	Class I, Groups B, C & D Class II, Groups E, F & G	Explosion-proof Housing NEMA 7	Requires Input Power to Operate.
G, H	1/2" FNPT Conduit with 18" LNG, 18 AWG Colored Flying Leads	NONE	CSA Listed Weather-proof Housing NEMA 4	Does not require Input Power to Operate.
J, K	1/2" FNPT Condulet Enclosure with 18" LNG, 18 AWG Colored Flying Leads	NONE	CSA Listed Weather-proof Housing NEMA 4	Does not require Input Power to Operate.

# Mid-West<sup>®</sup> Instrument

## Standard Dial Ranges Models: 105 & 106

Range Type			
PSID	H <sub>2</sub> O	Kpa	Bar
0-.50	0-10"	0-25	0-.5
0-1	0-20"	0-35	0-1.0
0-2	0-30"	0-60	0-1.75
0-3	0-40"	0-100	0-2.0
0-5	0-50"	0-135	
0-10	0-60"		
0-15	0-70"		
0-20	0-80"		
0-25	0-100"		
0-30	0-150"		
	0-200"		
	0-250"		
	0-300"		
	0-400"		
	0-500"		
	0-600"		
	0-800"		

The above mentioned ranges are some of the most popular requested today. Mid-West Instrument can provide special un-cataloged dial range requirements. As well as dual scale dials, multiple color dials and special decals. Please consult factory for complete information.

Uni-Directional Dial Ranges are available in either LINEAR or SQUARE ROOT FLOW SCALES with any appropriate legend ( I.E. PSID, Kpa, IN H <sub>2</sub> O, GPM, SCFM, ETC) at no extra charge			LINEAR Bi-Directional Dials are available with any appropriate Legend at No Charge	
0-0.5	0-30	0-300	1.0-0-1.0	75-0-75
0-1.0	0-35	0-400	2.0-0-2.0	100-0-100
0-1.6	0-40	0-500	5.0-0-5.0	150-0-150
0-2.0	0-50	0-600	10-0-10	200-0-200
0-3.0	0-60	0-700	15-0-15	300-0-300
0-4.0	0-70	0-800	25-0-25	400-0-400
0-5.0	0-75	0-900	30-0-30	750-0-750
0-6.0	0-80	0-1000	50-0-50	1000-0-1000
0-7.0	0-100	0-1500		
0-8.0	0-135	0-1600		
0-10	0-150	0-2000		
0-15	0-160	0-3000		
0-20	0-200	0-4000		
0-25	0-250	0-5000		
		0-6000		

Model	Min. ΔP Range	Max. ΔP Range
105	0-10" H <sub>2</sub> O (0-25 mbar)	0-79.9" H <sub>2</sub> O (0-200 mbar)
106	0-80" H <sub>2</sub> O (0-200 mbar)	0-800" H <sub>2</sub> O (0-30 PSID) (0-2 bar)

**Standards:** Models 105/106 gauges either conform to and/or are designed to the requirements of the following standards:

- |                            |                             |
|----------------------------|-----------------------------|
| ASME B1.20.1               | NACE MR0175                 |
| CSA-C22.2 No. 14.25 and 30 | SAE J514                    |
| ASME B40.100               | NEMA Std. No. 250           |
| EN-61010-1                 | UL Std. No. 50,508 and 1203 |

**Standard Model Specifications: 105-FE-00-00 / 106-FE-00-00**

1500 PSIG Working Pressure, Aluminum Body, Stainless Steel Bellows, Stainless Steel Internals  
 Buna-N Seals, 1/4" FNPT Dual Top & Bottom Connections, 6" Uni-Directional Round Dial,  
 Weather Resistant Engineered Plastic Case with Shatter Resistant Acrylic Lens,  
 Accuracy ±1% Full Scale (Ascending)

**Mid-West Instrument**

1-800-648-5778

**Range 105: 0-10 IN H<sub>2</sub>O to 0-79.9 IN H<sub>2</sub>O (0-.4 PSID to 0-2.9 PSID)**  
**Range 106: 0-80 IN H<sub>2</sub>O to 0-800 IN H<sub>2</sub>O (0-3 PSID to 0-30 PSID)**

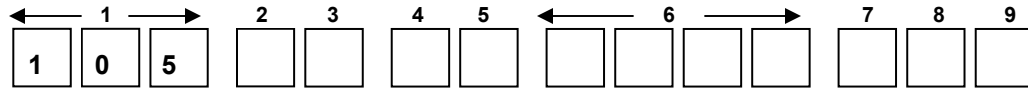

Basic Model

Range: \_\_\_\_\_



2	Material (Not All Options Available in Combination with other Options)
F	1500 PSIG, Aluminum Body, Stainless Steel Internals
G	3000 PSIG, Aluminum Body, Stainless Steel Internals
M	1500 PSIG, Mild Carbon Steel Body, Stainless Steel Internals
N	3000 PSIG, Mild Carbon Steel Body, Stainless Steel Internals
Q	1500 PSIG, 316 Stainless Steel Body, Stainless Steel Internals
R	3000 PSIG, 316 Stainless Steel Body, Stainless Steel Internals
T	6000 PSIG, 316 Stainless Steel Body, Stainless Steel Internals
X	1500 PSIG, Brass Body, Stainless Steel Internals
Y	500 PSIG, Brass Body, Stainless Steel Internals
3	Dial Size Type
E	Accuracy ±1% Full Scale Uni-Directional Dial w/Engineered Plastic Dial Case (Standard)
F	Accuracy ±1% Total Span Bi-Directional Dial w/Engineered Plastic Dial Case
G	Accuracy ±1/2% Full Scale Uni-Directional Dial w/Engineered Plastic Dial Case (30" WC & above only)**
Z	Special (Un-coded Options) <b>Note **G" Option not available for square root dials</b>
4	Seal Materials
0	Buna-N (Standard)
1	Viton®-A Registered Trademark of Dupont
5	Neoprene
9	Special (Un-coded Options)
5	Process Connections
0	1/4" FNPT Top & Bottom Connections (Standard)
9	Special (Un-coded Options)

**Proof Pressure:** Two times rated working pressure or 10,000 PSI whichever is lower at ambient temperature.

**Temperature Limits:**  
 "Gauge Only" -40°F (-40°C) to +200°F (+95°C)  
 "Locked Logic Switch" -40°F (-40°C) to +160°F (+70°C)  
 "Micro Switch" -20°F (-29°C) to +185°F (+85°C)

These limits are based on the entire instrument being saturated to these temperatures. System (process) temperatures may exceed these limitations with proper installation. Contact our customer service representative for details.

## Standard Model Specifications – continued Model 105 / 106

6	Additional Options
O	NONE
F	Carbon Steel 2" Pipe Mounting Kit
G	Stainless Steel 2" Pipe Mounting Kit
H	1/4" Carbon Steel Compression Tube Fittings
J	1/4" Stainless Steel Compression Tube Fittings
K	1/2" FNPT Stainless Steel Adapters
N	NACE <b>(Available for Aluminum &amp; Stainless Steel Gauge Bodies only)</b>
Q	CRN (Canadian Registration Number) <b>Only available on Models 105Q &amp; 106Q</b>
S	Shatter Proof Glass Lens
T	Oxygen Cleaning
U	Stainless Steel Tag with S.S. Wire
V	Stainless Steel Tag and S.S. Screw
W	Wall Mount Kit
Y	4-1/2" Dial Case
Z	Special <b>(Un-coded Options)</b>
7	Electrical Configurations Note: G,H,J & K switch option (high port on right when facing dial)
A	One (1) Switch in Weather Proof enclosure
B	Two (2) Switches in Weather Proof enclosure
C	One (1) Switch in explosion proof enclosure Class 1, Groups B, C, & D <b>(Pipe Mounting Kit Standard)</b>
D	Two (2) Switch in explosion proof enclosure Class 1, Groups B, C, & D <b>(Pipe Mounting Kit Standard)</b>
G	One (1) Micro-Switch in Weather Resistant Enclosure (2) (MODEL 106 0-80" to 0-800" H2O only) Accuracy ±2%
H	Two (2) Micro-Switches in Weather Resistant Enclosure (MODEL 106 0-80" to 0-800" H2O only) 0-80" - 199" H2O Accuracy ±4% / 0-200" H2O and above Accuracy ±2% <b>(1) (2)</b>
J	One (1) Micro-Switch in Weather Resistant Housing with Condulet Enclosure (2) (MODEL 106 0-80" to 0-800" H2O only) Accuracy ±2%
K	Two (2) Micro-Switches in Weather Resistant Housing with Condulet Enclosure (MODEL 106 0-80" to 0-800" H2O only) 0-80" - 199" H2O Accuracy ±4% / 0-200" H2O and above Accuracy ±2% <b>(1) (2)</b>
Z	Special <b>(Un-coded Options)</b>
<b>(1)</b> Accuracies & repeatability values for (2) switch units are based upon (1) switch set low (approx. 25% for FSR) and (1) switch set high <b>(2)</b> CSA Listed, Type 4, Industrial Control Equipment	
8	"Input Options" Electrical Specifications (Select (1) input and (1) output option)
A	8-28 Vdc
B	115 VAC 50/60 Hz
C	220/240 VAC 50/60Hz
N	No Input Required for Micro-Switch Options: G, H, J & K
Z	Special <b>(Un-coded Options)</b>
9	"Output Options" (Resistive Load)
<b>(Resistive load) – 10 Amp @ 28 VDC, 115/230 VAC (50/60 Hz)</b> (1/2" NPT, 24" Flying Leads standard interface) (1/2" NPT, 24" Flying for two (2) DPDT switches)	
A	SPDT Relays
C	SPST Relays
D	Adjustable Deadband, one (1) SPDT output (two (2) control switches only)
E	Adjustable Deadband, one (1) DPDT output (two (2) control switches only)
<b>Micro Switch Electrical Interface:</b> 18", 18 Awg, 600 V, 105°C / Color coded wire leads from 1/2" FNPT Connection	
M	SPDT Micro-Switch Contact Ratings: <b>(MAX)</b> 4 Amps @ 30 VDC / 3 Amps @ 240VAC / 5 Amps @ 120 VAC
Z	Special <b>(Un-coded Options)</b>
<b>Factory preset switches at no charge (specify setting)      Contact factory for bi-directional scales</b>	

**NOTE:** The use of Diaphragm seals is not recommended for Model 105/106 gauges.  
Attempts to install such seals on these gauges will void warranty.



# Mid-West<sup>®</sup> Instrument



*Now Available!*

## Model 105 TANK LEVEL GAUGE for LIQUID HYDROGEN SERVICE



*No Liquid Fill required*

*Over-Range Protection  
High over Low  
and Low over High!*



Mid-West Model 105 bellows design provides a simple, compact, accurate, direct-acting, low range differential pressure level indicator. Accuracy  $\pm 1\%$  of Full Scale

**Range Model 105: 0-10" H<sub>2</sub>O to 0-50" H<sub>2</sub>O (25 mbar to 125 mbar)**

### Benefits:

- Stainless Steel Gauge Front, Stainless Steel Body with Shatter-Proof Glass Lens.
  - Provides superior safety and corrosion resistance.
- Dry gauge design with no internal liquid fill
  - No costly clean up from liquid fill leaking
  - No chance of unacceptable or incompatible fill fluid being in the gauge.
  - No gauge damage/accuracy loss caused by liquid fill expansion or contraction when exposed to temperature extremes in Hydrogen level applications.
- Single bellows design is more compact and light weight.
  - Substantial weight savings over competitive range gauges.
  - Can be panel mounted in a one piece panel.
  - Can be mounted on tanks using std. 2" pipe mount brackets or 3/4" pipe nipple brackets.
- Mid-West Instrument performs Helium leak testing on units for Hydrogen service.

### Product Description:

The Model 105 design is an all-stainless steel differential pressure gauge capable of operating at low differential pressures. Safe working pressure is 1500 PSIG standard. The DPI is equipped with a Bi-directional Over Pressure Relief Valve (OPV). When the Differential Pressure exceeds 130% of the range the OPV equalizes the pressure between the Hi and Lo side's 1/4" FNPT Dual top and bottom connections are provided as standard. The DPI is also equipped with a Micro adjust pointer, If necessary the pointer can be re-zeroed. Body is made of stainless steel with 316 Stainless Steel internals. Viton Seals are provided as standard with other elastomers available. Dial is 6" diameter with white lettering on a black dial.(white dial with black lettering optional) The temperature limits are rated at -40°C to 200°F. Proof pressure is two times working pressure at ambient temperatures.



**Product Features:**

- Ability to create custom dials for horizontal and vertical tanks
- Various Dial layouts available: **Single Scale, Dual Scale and Tri-Scale**
- Micro-Adjust pointer (if necessary the pointer can be re-zeroed)
- In house Oxygen Cleaning (optional)
- Private Labeling (optional)
- White ink on Black dial or Black ink on White dial
- **Industry best lead time reduces inventory requirements**



**Gauge Specifications**

<b>105</b>	
<b>Accuracy</b>	±1% of Full Scale
<b>DP Range</b>	0-10" H2O to 0-50" H2O (25 mbar to 125 mbar)
<b>Safe Working Pressure</b>	1500 PSIG (3000 PSIG optional)
<b>Body Material</b>	316 Stainless Steel
<b>Dial Case &amp; Bezel</b>	316 Stainless Steel
<b>Internals</b>	316 Stainless Steel Multiple Bellows
<b>Port</b>	Dual Top and Bottom, 1/4" FNPT connections with optional snubbers
<b>Seals</b>	Viton® Standard, other elastomers available
<b>Dial</b>	6" Black dial with White lettering (White dial with Black lettering optional)
<b>Standard Mounting</b>	Panel Mountable
<b>Optional Mounting</b>	2" Pipe Mount
<b>Warranty</b>	Five Year

**50 YEARS** experience in the field of supplying quality Differential Pressure Gauges.

**Proof Pressure:** Two times working pressure at ambient temperatures

**Temperature Limits:** -40°F (-40°C) to 200°F (93°F)

**Standards:**

**ASME B1.20.1      CSA-C22.2 No.14      NEMA Std. No. 250**  
**ASME B40.100      UL Std. No. 50      SAE J514**

# BOURDON TUBE STYLE GAUGE

---



For Installation and Operation Manuals  
Please Visit: [www.midwestinstrument.com/literature](http://www.midwestinstrument.com/literature)

---

**Mid-West**  
Instrument



# Mid-West<sup>®</sup> Instrument

## “Bourdon Tube Type”

### Differential Pressure Gauge & Switches

#### Model 109



#### “LOCKED LOGIC” ALARM CONTROLS

(Available with 1 or 2 switches for alarm & control)

**Over Range Protection high-low and low-high to rated working pressure by use of a bi-directional relief valve**

**Model 109 DP Range:** 0-15 PSID (0-1.0 bar) to 0-6000 PSID (0-400 bar)

- Bourdon Tube design provides a simple, compact, accurate, direct-acting, high accuracy differential pressure indicator.
- Easier and less expensive to service/repair than competitive units.
- Working pressures of 500, 1500, 3000, or 6000 PSIG (400 bar).
- Housing materials: Aluminum, Brass, Carbon Steel, or 316L Stainless Steel
- Internals: Copper-Alloy or Stainless Steel Bourdon Tube.
- Available Elastomers: Buna-N, Viton, Neoprene, Ethylene Propylene
- Mechanical over-range protection to maximum working pressure
- Weather resistant dial case of Engineered Plastic with Shatter resistant acrylic lens
- Panel Mounting Standard
- Uni-directional or Bi-directional dials are readily available.
- Gauges are optionally available with one or two switches which offer's the ability to have alarm or control.



**Model 109** ( $\pm 1/2\%$  or  $\pm 1\%$  Full Scale Accuracy) System pressure is applied to the inside of a slightly flattened arc-shaped tube. As pressure increases, the tube tends to restore to its original round cross-section. This change in cross-section causes the tube to straighten. Since the tube is permanently fastened at one end, the tip of the tube traces a curve that is the result of the change in angular position with respect to the center. Powered by a test quality Bourdon Tube assembly, the assembly is encapsulated in a high pressure chamber that is fitted with a pressure connection to the inside of the Bourdon Tube and a second connection to the pressure chamber.

Model	Accuracy	Min. $\Delta P$ Range	Max. $\Delta P$ Range	Safe Working Pressure PSIG (bar)	Optional Switches
109	$\pm 1/2\%$ or $1\%$	0-15 PSID (0-1.0 bar)	0-6000 PSID (0-400 bar)	500-6000 (34-400)	1 or 2

**Model 109** assembly incorporates a bi-directional relief valve which provides over-pressure protection in both directions. When over-pressured from the high side, the valve is opened by a mechanical stop as the sensing element deflects to its maximum travel. When over-pressured from the low side, the spring-loaded valve opens when the differential pressure exceeds its maximum rating. The opening of the valve in either direction equalizes the pressure and protects the unit. A range spring is provided to adjust the spring rate of the system to suit the various differential pressure ranges of the instrument.



# “Bourdon Tube Type” Differential Gauge Switch Options Model 109



## "LOCKED LOGIC" SOLID STATE ALARM-CONTROL FOR ALL 109 GAUGE (NOTE - 6" DIAL SIZE ONLY)

If your application requires switching in addition to local indication, our all solid state "Locked Logic" system is the most accurate available. With no moving cams, levers, etc. it does not affect the accuracy of the gauge on which it is installed. Switch accuracy is the same as the gauge accuracy. Visible set pointers are provided, adjustable to within 5% of full scale of each other. The set points are adjustable from 5 to 95% of full scale. Internal adjustment is standard. 1-2 Independently adjustable switches with Set Point Feedback. SPDT or DPDT Output options, Adjustable deadband option for single SPDT or DPDT output (2 set pointers) Accuracy of Gauge unaffected by the switch

OPTION	INTERFACE	MARKINGS	ENVIRONMENTAL	COMMENTS
<b>A, B</b>	1/2" Conduit with 24" 18 AWG Color Coded Flying Leads 3/4" FNPT for (2) DPDT Outputs	None	NEMA 4X	Requires Input Power to operate.
<b>C, D</b>	1/2" Conduit with 24" 18 AWG Color Coded Flying Leads 3/4" FNPT for (2) DPDT Outputs	NONE Class I, Div 1, Groups B, C, & D Class II, Div 1, Groups E, F, & G.	NEMA 4X NEMA 7(OPTIONAL)	Explosion-proof enclosure. Requires Input Power to Operate.

"MODEL 109 ELECTRICAL CONFIGURATIONS"	
<b>A</b>	One (1) Switch in Weather Proof enclosure
<b>B</b>	Two (2) Switches in Weather Proof enclosure
<b>C</b>	One (1) Switch in explosion proof enclosure Class I, Groups B, C, & D ( <b>Pipe Mounting Kit Standard</b> )
<b>D</b>	Two (2) Switch in explosion proof enclosure Class I, Groups B, C, & D ( <b>Pipe Mounting Kit Standard</b> )
"INPUT OPTIONS" ELECTRICAL SPECIFICATIONS (Select (1) input and (1) output option)	
<b>A</b>	8-28 Vdc
<b>B</b>	115 VAC 50/60 Hz
<b>C</b>	220/240 VAC 50/60Hz
<b>Z</b>	Special ( <b>Un-Coded Options</b> )
"OUTPUT OPTIONS" ELECTRICAL SPECIFICATIONS (Resistive Load)	
<b>(Resistive load) – 10 Amp @ 28 VDC, 115/230 VAC (50/60 Hz)</b> (1/2" NPT, 24" Flying Leads standard interface) (1/2" NPT, 24" Flying for two (2) DPDT switches)	
<b>A</b>	SPDT Relays
<b>C</b>	SPST Relays
<b>D</b>	Adjustable deadband, one (1) SPDT output (two (2) control switches only)
<b>E</b>	Adjustable deadband, one (1) DPDT output (two (2) control switches only)

Factory preset switches at no charge (**Specify Setting**)

**Proof Pressure:** Two times rated working pressure at ambient temperature

**Temperature Limits:**                    **“Gauge Only”** -40°F (-40°C) to +200°F (+95°C)  
   **“Locked Logic Switch”** -40°F (-40°C) to +160°F (+70°C)

These limits are based on the entire instrument being saturated to these temperatures. System (process) temperatures may exceed these limitations with proper installation. Contact our customer service representative for details.

**Standards:** Model 109 gauge either conforms to and/or is designed to the requirements of the following standards:

- |                            |                             |
|----------------------------|-----------------------------|
| ASME B1.20.1               | NACE MR0175                 |
| CSA-C22.2 No. 14.25 and 30 | SAE J514                    |
| ASME B40.100               | NEMA Std. No. 250           |
| EN-61010-1                 | UL Std. No. 50,508 and 1203 |

# Mid-West<sup>®</sup> Instrument

## Standard Dial Ranges Model: 109

Range Type					
PSID	H <sub>2</sub> O	Kpa	Bar	Bi-Directional	Dual Scale
0-15	0-400"	0-160	0-1.6	15-0-15 PSID	0-15 PSID & 0-1 Kg/cm <sup>2</sup>
0-20	0-500"	0-200	0-2.5	25-0-25 PSID	0-25 PSID & 0-1.75 Kg/cm <sup>2</sup>
0-25	0-600"	0-250	0-4.0	30-0-30 PSID	0-30 PSID & 0-200 Kpa
0-30		0-400	0-6.0	50-0-50 PSID	0-50 PSID & 0-350 Kpa
0-50		0-600	0-7.0	75-0-75 PSID	0-60 PSID & 0-400 Kpa
0-60		0-700		100-0-100 PSID	0-100 PSID & 0-700 Kpa
0-75				150-0-150 PSID	0-100 PSID & 0-7 Kg/cm <sup>2</sup>
0-100				200-0-200 PSID	
0-150				300-0-300 PSID	
0-200				400-0-400 PSID	
0-250				750-0-750 PSID	
0-300				1000-0-1000 PSID	
0-500					
Up to 6000					

The above mentioned ranges are some of the most popular requested today. Mid-West Instrument can provide special un-cataloged dial range requirements. As well as dual scale dials, multiple color dials and special decals. Please consult factory for complete information.

Model	Min. ΔP Range	Max. ΔP Range
109	0-15 PSID (0-1.0 bar)	0-6000 PSID (0-400 bar)

Uni-Directional Dial Ranges are available in either LINEAR or SQUARE ROOT FLOW SCALES with any appropriate legend ( I.E. PSID, Kpa, IN H <sub>2</sub> O, GPM, SCFM, ETC) at no extra charge			LINEAR Bi-Directional Dials are available with any appropriate Legend at No Charge		
0-0.5	0-30	0-300	1.0-0-1.0	75-0-75	
0-1.0	0-35	0-400	2.0-0-2.0	100-0-100	
0-1.6	0-40	0-500	5.0-0-5.0	150-0-150	
0-2.0	0-50	0-600	10-0-10	200-0-200	
0-3.0	0-60	0-700	15-0-15	300-0-300	
0-4.0	0-70	0-800	25-0-25	400-0-400	
0-5.0	0-75	0-900	30-0-30	750-0-750	
0-6.0	0-80	0-1000	50-0-50	1000-0-1000	
0-7.0	0-100	0-1500			
0-8.0	0-135	0-1600			
0-10	0-150	0-2000			
0-15	0-160	0-3000			
0-20	0-200	0-4000			
0-25	0-250	0-5000			
		0-6000			

## Standard Model Specifications: 109-FE-00-00

1500 PSIG Working Pressure, Aluminum Body, Stainless Steel Bourdon Tube, Stainless Steel Internals  
 Buna-N Seals, 1/4" FNPT Back Connections (Stainless Steel), 6" Uni-Directional Round Dial,  
 Weather Resistant Engineered Plastic Case with Shatter Resistant Acrylic Lens,  
 Accuracy ±1% Full Scale (Ascending)

**Mid-West Instrument**

**1-800-648-5778**

**Range: 0-15 PSID to 0-6000 PSID (0-1.0 bar to 0-400 bar)**

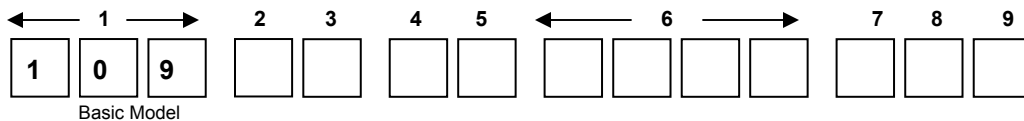

Range: \_\_\_\_\_



2	Material
<b>C</b>	1500 PSIG, Aluminum Body, Copper Alloy Internals (1/4" FNPT Connections / Carbon Steel)
<b>D</b>	3000 PSIG, Aluminum Body, Copper Alloy Internals (1/4" FNPT Connections / Carbon Steel)
<b>F</b>	1500 PSIG, Aluminum Body, S.S. Internals (1/4" FNPT Connections / 316 Stainless Steel)
<b>G</b>	3000 PSIG, Aluminum Body, S.S. Internals (1/4" FNPT Connections / 316 Stainless Steel)
<b>M</b>	1500 PSIG, Mild Carbon Steel Body, S.S. Internals (1/4" FNPT Connections / 316 Stainless Steel)
<b>N</b>	3000 PSIG, Mild Carbon Steel Body, S.S. Internals (1/4" FNPT Connections / 316 Stainless Steel)
<b>Q</b>	1500 PSIG, 316 Stainless Steel Body, S.S. Internals (1/4" FNPT Connections / 316 Stainless Steel)
<b>R</b>	3000 PSIG, 316 Stainless Steel Body, S.S. Internals (1/4" FNPT Connections / 316 Stainless Steel)
<b>T</b>	6000 PSIG, 316 Stainless Steel Body, S.S. Internals (1/4" FNPT Connections / 316 Stainless Steel)
<b>U</b>	1500 PSIG, Brass Body, Copper Alloy Internals (1/4" FNPT Connections / Brass)
<b>V</b>	500 PSIG, Brass Body, Copper Alloy Internals (1/4" FNPT Connections / Brass)
<b>X</b>	1500 PSIG, Brass Body, S.S. Internals (1/4" FNPT Connections / 316 Stainless Steel)
<b>Y</b>	500 PSIG, Brass Body, S.S. Internals (1/4" FNPT Connections / 316 Stainless Steel)
3	Dial Size Type
<b>E</b>	Accuracy ±1% Full Scale Uni-Directional Dial w/Engineered Plastic Dial Case ( <b>Standard</b> )
<b>F</b>	Accuracy ±1% Total Span Bi-Directional Dial w/Engineered Plastic Dial Case ( <b>±3% above 1500-0-1500 PSI</b> )
<b>G</b>	Accuracy ±1/2% Full Scale Uni-Directional Dial w/Engineered Plastic Dial Case ( <b>Not available above 1000 PSID</b> )
<b>Z</b>	Special ( <b>Un-coded Options</b> ) <span style="float: right;"><b>Note: **G" Option not available for square root dials</b></span>
4	Seal Materials
<b>0</b>	Buna-N ( <b>Standard</b> )
<b>1</b>	Viton®-A Registered Trademark of Dupont
<b>2</b>	Neoprene
<b>5</b>	Ethylene Propylene
<b>6</b>	Perfluorelastomers
<b>9</b>	Special ( <b>Un-coded Options</b> )
5	Process Connections
<b>0</b>	1/4" FNPT Back Connections ( <b>Standard</b> )
<b>5</b>	1/2" FNPT Back Connections ( <b>Stainless Steel</b> )
<b>9</b>	Special ( <b>Un-coded Options</b> )

## Standard Model Specifications – continued Model 109

6	Additional Options
<b>O</b>	NONE
<b>B</b>	Drain & Bleed Connections (1/8" FNPT) Brass
<b>C</b>	Drain & Bleed Connections (1/8" FNPT) 316 Stainless Steel
<b>F</b>	Carbon Steel 2" Pipe Mounting Kit <b>(Standard on Explosion Proof Locked Logic Units)</b>
<b>H</b>	1/4" Carbon Steel Compression Tube Fittings
<b>J</b>	1/4" Stainless Steel Compression Tube Fittings
<b>L</b>	Liquid Fill
<b>M</b>	Maximum Indicator Follower Pointer <b>(Not available with Liquid fill option)</b>
<b>N</b>	NACE <b>(Available for Aluminum &amp; Stainless Steel Gauge Bodies only)</b>
<b>Q</b>	CRN (Canadian Registration Number) <b>Only available on Models 109F, M or Q.</b>
<b>S</b>	Shatter Proof Glass Lens
<b>T</b>	Oxygen Cleaning
<b>U</b>	Stainless Steel Tag with S.S. Wire
<b>V</b>	Stainless Steel Tag and S.S. Screw
<b>W</b>	Wall Mount Kit
<b>Y</b>	4-1/2" Dial Case
<b>Z</b>	Special <b>(Un-coded Options)</b>
7	Electrical Configurations
<b>O</b>	NONE
<b>A</b>	One (1) Switch in Weather Proof enclosure
<b>B</b>	Two (2) Switches in Weather Proof enclosure
<b>C</b>	One (1) Switch in explosion proof enclosure Class I, Groups B, C, & D <b>(Pipe Mounting Kit Standard)</b>
<b>D</b>	Two (2) Switch in explosion proof enclosure Class I, Groups B, C, & D <b>(Pipe Mounting Kit Standard)</b>
8	"Input Options" Electrical Specifications (Select (1) input and (1) output option)
<b>A</b>	8-28 Vdc
<b>B</b>	115 VAC 50/60 Hz
<b>C</b>	220/240 VAC 50/60Hz
<b>Z</b>	Special (Un-coded Options)
9	"Output Options" (Resistive Load)
<b>(Resistive load) – 10 Amp @ 28 VDC, 115/230 VAC (50/60 Hz)</b>	
(1/2" NPT, 24" Flying Leads standard interface)	
(1/2" NPT, 24" Flying for two (2) DPDT switches)	
<b>A</b>	SPDT Relays
<b>C</b>	SPST Relays
<b>D</b>	Adjustable deadband, one (1) SPDT output (two (2) control switches only)
<b>E</b>	Adjustable deadband, one (1) DPDT output (two (2) control switches only)
<b>Z</b>	Special (Un-coded Options)
<b>Not All Options Available in Combination with other Options</b>	

**MID-WEST INSTRUMENT** has been serving a variety of industries (Power, Chemical, Petro-Chemical, HVAC, Water Filtration etc... for over 50 years. Over 1,000,000 DP Gauges have been produced bearing the Mid-West name or private branded for our OEM customers!

Mid-West understands that in today's demanding environment, flexibility, quick response time and the ability to ship most of our product line in 2 weeks or less is essential to our customers.

Standard configurations can be customized and modified to suit our customer's needs for ease of installation or retrofit. If you are in need of additional information please visit our web site at [www.midwestinstrument.com](http://www.midwestinstrument.com) or contact us toll free at **1-800-648-5778** and one of our knowledgeable sales coordinators will be happy to assist you.





# TANK LEVEL GAUGES

---



For Installation and Operation Manuals  
Please Visit: [www.midwestinstrument.com/literature](http://www.midwestinstrument.com/literature)

---

**Mid-West**  
Instrument





# Mid-West<sup>®</sup> Instrument

## “Bellows Type Tank Level” Differential Pressure Level Gauge & Switch Model 115/116



**Model 115, 0-10” H<sub>2</sub>O to 0-69.9” H<sub>2</sub>O (25 mbar to 2.5 PSID)**

**Model 116, 0-70” H<sub>2</sub>O to 0-800” H<sub>2</sub>O (2.5 PSID to 30 PSID)**

Model 115/116 multiple diaphragm/bellows design provides a simple, highly accurate, direct-acting, differential pressure indicator. Full Scale Accuracy of  $\pm 1\%$ .

Typical applications include; Level measurement in closed tanks for the Industrial Liquid Gas Industry. Use with gaseous and liquid media, provide they are not highly viscous. Various Dial scales available to match a wide variety of gases such as He, Ar, O<sub>2</sub>, N<sub>2</sub>, CO<sub>2</sub>, Helium and Hydrogen

### **BENEFITS:**

“Engineered Plastic” gauge front and stainless steel body bolts provide corrosion resistance in “over the road Trailers” outdoor and salt air environments.

Up to a 30 lb. weight savings over competitive Liquid Helium range gauges

- Allows more product to be transported in mobile trailers
- Easier and less labor to panel mount

Low & High range capabilities

- Ideal for He, Ar, O<sub>2</sub>, N<sub>2</sub>, CO<sub>2</sub>, Helium and Hydrogen tank level applications
- For use on Stationary, Over the Road, ISO/IMO containers and LNG bulk tanks

Industry best lead time reduces inventory requirements

Adaptable to wide variety of mounting configurations

Private Brand and Custom Dials available: *Single Scale, Dual Scale, and Tri-Scale*

**OVER 50 YEARS** experience in the field of supplying quality Differential Pressure Gauges. Tank Level applications are for stationary, over the road, ISO/IMO containers and LNG bulk tanks

**Product Description:**

Model 115 and 116 design is an all-metal differential pressure gauge capable of operating at low differential pressures. Safe working pressure is 500 PSIG (STD) 1,000 PSIG (optional)

The DPI is equipped with a Bi-directional Over Pressure Relief Valve (OPV). When the Differential Pressure exceeds 130% of the range the OPV equalizes the pressure between the Hi and Lo sides. 1/4" FNPT Dual top and bottom connections are provided as standard. The DPI is also equipped with a Micro adjust pointer, If necessary the pointer can be re-zeroed. Body is made of brass with 316 Stainless Steel internals. Viton Seals are provided as standard. The Dial is 6" diameter with white lettering on a black dial. (white dial with black lettering optional) The 115/116 temperature limits are rated at -40°C to 200°F. Proof pressure is Two Times working pressure at ambient temperature.

Model 116 can be equipped with one or two independently adjustable SPDT snap acting Micro-Switches which can be set on decreasing or on increasing pressure. A switch adjustment screw and a switch lock screw is accessible after removal of the lens and bezel (removal of 4 screws). Interface to the snap acting micro-switch is via color coded 18 AWG flying leads and a 1/2" FNPT conduit connection. Model 116 with switch temperature limits are rated at -20°C to +185°F



Model 116 Brass Cast Body



Model 116 shown with Optional S.S. 3-Valve manifold mounted to gauge body

**MANIFOLD SPECIFICATIONS:**

**Pressure rating:** 6000 PSIG (414 bar) @ 200°F (93°C) or 4000 PSIG (276 bar) @ 500°F (260°C)

**Mini-Manifold:** 3000 PSIG (207 bar) @ 200°F (93°C)

**Isolated stem threads:** Adjustable packing below stem keeps process fluid away.

Ensures leak proof long service life. Bubble-tight shutoff.

**Process Connections:** Standard 3 & 5 Valve = 1/2" FNPT / 3-Valve Mini-Manifold: = 1/4" FNPT

**Replaceable seat design:** Standard 3/16 inch diameter orifice.

**Bonnet cap protection:** Increases valve life protecting stem threads from atmospheric corrosion.

**Rolled stem threads:** Increased strength and life

**No more stem blowouts:** Backseat stem design prevents blowout problems.

**Less Parts:** Less leak points and less fugitive emissions.

**Test Ports:** 3 & 5 Valve Manifold = 1/4" FNPT ports which may be used as test connections

3-Valve Mini-Manifold = 1/8" FNPT port test connections

3 & 5 Valve Manifold = **Teflon Packing, Integral (Body Material) Seat, and Stainless Steel Body**

3-Valve Mini-Manifold = **Teflon Packing, Delrin Seat, and Stainless Steel Body**

# Model 115/116 Tank Level Gauge

0-400" H<sub>2</sub>O  
Single Switch



**Model 105**  
0-10" H<sub>2</sub>O / Single Scale



**Optional**  
**3/4" FNPT**  
**Stub Mount Shown**



**Ar, O<sub>2</sub>, N<sub>2</sub>**  
**Tri-Scale Dial**

	<b>115</b>	<b>**116</b>
<b>Accuracy</b>	±1% of Full Scale	
<b>DP Range</b>	0-10" H <sub>2</sub> O to 0-69.9" H <sub>2</sub> O (25 mbar to 2.5 PSID)	0-70" H <sub>2</sub> O to 0-800" H <sub>2</sub> O (2.5 PSID to 30 PSID)
<b>Safe Working Pressure</b>	1500 PSIG	500 PSIG (Standard) 1000 PSIG (Optional)
<b>Body Material</b>	Brass	Brass
<b>Internals</b>	316 S.S. Welded Multiple Diaphragm	316 S.S. Convuluted Bellows
<b>Port</b>	Dual Top and Bottom, 1/4" FNPT connections with optional snubbers	
<b>Seals</b>	Viton Standard, other elastomers available	
<b>Dial</b>	6" Black dial with White lettering (White dial with Black lettering optional)	
<b>Warranty</b>	One Year	
<b>**Model 116 Snap Acting Micro-Switch for Alarm (optional)</b> <b>Ranges: 0-80" H<sub>2</sub>O &amp; above.</b>		
<b>Aluminum, Carbon Steel, &amp; Stainless Steel Body Materials Available...</b> <b>Ask about Model's 105, and 106 ( SWP of 1,500 &amp; 3,000 PSIG)</b>		



**MICRO - SWITCH SPECIFICATION**  
**Model 116 Electrical 0-80" H<sub>2</sub>O and above**

<b>Input Voltage:</b>	None Required		
<b>Set Pointers:</b>	Quantity	1	With visual set point set on decreasing pressure
	Adjustment:	3% to 100% of Full Scale	
<b>Output(s)</b>	Contact(s)	1 SPDT	@ 30 VDC @ 240 VAC @ 120 VAC
	Contact Rating:	4 Amps Maximum 3 Amps Maximum 5 Amps	
<b>Temperature:</b>	Operating:	-20°F to +185°F	
<b>Environment:</b>	Standard:	Weather-Proof Housing	NEMA 4
<b>Electrical Interface:</b>	Standard:	1/2", 18 Awg., 600 V 105C Color Coded Wire Leads	1/2" FNPT
<b>Gauge Accuracy:</b>	2%	Including Effects of the switch	
<b>Switch Repeatability:</b>	2%	Maximum	

**Proof Pressure:**

Two times working pressure at ambient temperatures

**Temperature Limits:**

Gauge w/o/ switch -40°F to 200°F  
 Gauge with Snap Acting Switch -20°F to 185°F

These limits are based on the entire instrument being saturated to these temperatures. System (process) temperatures may exceed these limitations with proper installation. Contact our customer service representative for details.

**Standards:** Model 115/116 Series gauges either conform to and/or are designed to the requirements of the following standards:

- |              |                 |                   |
|--------------|-----------------|-------------------|
| ASME B1.20.1 | CSA-C22.2 No.14 | NEMA Std. No. 250 |
| ASME B40.100 | UL Std. No. 50  | SAE J514          |

# Mid-West<sup>®</sup> Instrument

## Standard Tank Level Gauge Ranges: Model 115/116

PSID	H2O	Kpa	Bar	Range Type	
				Dual Scale IN/CM	CM & MMH2O
0-3	0-70"	0-20	0-.35	0-80 IN H2O/0-200 CM H2O	0-200 CM H2O
0-5	0-80"	0-35	0-.7	0-100 IN H2O/0-250 CM H2O	0-380 CM H2O
0-10	0-100"	0-70	0-1.0	0-150 IN H2O/0-380 CM H2O	0-500 CM H2O
0-15	0-120"	0-100	0-1.4	0-200 IN H2O/0-500 CM H2O	0-1000 CM H2O
0-20	0-150"	0-140	0-1.75	0-300 IN H2O/0-750 CM H2O	0-1024 CM H2O
0-25	0-200"	0-172	0-2.0	0-400 IN H2O/0-1000 CM H2O	0-1250 CM H2O
0-30	0-250"	0-200		0-500 IN H2O/0-1270 CM H2O	0-1500 CM H2O
	0-300"			0-600 IN H2O/0-1500 CM H2O	0-1524 CM H2O
	0-400"			0-700 IN H2O/0-1800 CM H2O	0-2500 MM H2O
	0-450"			0-800 IN H2O/0-2050 CM H2O	0-3,000 MM H2O
	0-500"				0-5,000 MM H2O
	0-600"				0-7,600 MM H2O
	0-700"				0-10,000 MM H2O
	0-800"				0-12,700 MM H2O
					0-15,000 MM H2O

The above mentioned ranges are some of the most popular requested today. Mid-West Instrument can provide special un-cataloged dial range requirements. As well as multiple scale dials, multiple color dials and special decals. Please consult factory for complete information.

Model 115 Range Conversions						
"H2O	CM H2O	MM H2O	PSID	Bar	mBar	Kpa
0-10	0-25	0-254	0-.36	0-.02	0-25	0-2.5
0-15	0-38	0-381	0-.54	0-.03	0-37	0-3.7
0-20	0-50.8	0-508	0-.72	0-.05	0-50	0-5
0-25	0-64	0-635	0-.90	0-.06	0-62	0-6.2
0-30	0-76.2	0-762	0-1.08	0-.07	0-75	0-7.5
0-40	0-101.6	0-1016	0-1.44	0-.09	0-100	0-10
Model 116 Range Conversions						
0-70	0-180	0-1775	0-2.5	0-.17	0-174	0-17.3
0-80	0-200	0-2032	0-2.9	0-.20	0-200	0-20
0-100	0-250	0-2540	0-3.6	0-.25	0-250	0-25
0-150	0-380	0-3810	0-5.4	0-.37	0-373	0-37
0-200	0-500	0-5080	0-7.2	0-.50	0-498	0-50
0-300	0-760	0-7620	0-10.8	0-.75	0-747	0-75
0-400	0-1000	0-10,200	0-14.5	0-.99	0-996	0-100
0-500	0-1270	0-12,700	0-18.0	0-1.2	0-1245	0-124
0-600	0-1500	0-15,240	0-21.6	0-1.5	0-1494	0-150
0-700	0-1800	0-17,750	0-25.3	0-1.74	0-1740	0-174
0-800	0-2000	0-20,300	0-28.9	0-2.00	0-2000	0-200



Listed below are examples of tank level dial ranges requested and provided to our customers based on their specific requirements. Mid-West has the capability to provide special dials to fit your specific needs.

Range	
0-100,000LBS CO2/0-46,000 KGS	0-28,000 LBS N2O
0-100% CARBON DIOXIDE	0-28,000LBS CO2/0-12,800 KGS
0-100% CO2	0-3,935 LBS CO2/0-1,785 KGS
0-100% LINEAR	0-36,000 LBS CO2/0-16,000 KGS
0-100,000 LBS CO2	0-400 IN H2O/0-10,160 MM H2O
0-100,000 LBS CO2/0-46,000 KGS	0-42,000 LBS CO2/0-19,000 KGS
0-100,000 LBS CO2/0-50 TONS	0-42,000 LBS N2O/0-21 TONS
0-100,000 LBS N2O	0-4300 GALLONS
0-100,000 LBS N2O/0-100%	0-5,500 LBS CO2/0-2,500 KGS
0-11 IN H2O/0-220 CM HE	0-50 IN H2O/0-1140 KG LOX
0-11 IN H2O/0-220 LHE	0-50,000 TONS & 0-100,000 LBS CO2
0-11 IN H2O/0-28 CM H2O	0-52,000 LBS CO2/0-24,000 KGS
0-11,000 LITRES O2/N2/AR	0-52,000 LBS CO2/0-26,000 TONS
0-12,000 Lbs CO2 / 0-6 TONS	0-56,000 LBS CO2/0-25,000 KGS
0-12,000 LBS CO2/0-5,400 KGS	0-6,000 LBS CO2/0-2,700 KGS
0-12,000 LBS CO2/0-5,500 KGS	0-60,000 LBS CO2
0-12,000 LBS CO2/0-6 TONS	0-60,000 LBS CO2/0-100%
0-120,000 LBS CO2/0-55,000KGS	0-60,000 LBS CO2/0-27,500 KGS
0-13,000 LBS CO2	0-60,000 LBS CO2/0-28,000 KGS
0-13,000 LBS H2O	0-60,000 LBS CO2/0-30,000 KGS
0-13000 LBS N2O	0-63 METRIC TONNES
0-16,000 LBS CO2/0-7,200 KGS	0-7,000 LBS CO2/0-3,150 KGS
0-182,000 LBS CO2 / 0-82,500 KGS	0-7,500LBS CO2/0-3,400 KGS
0-20,000 LBS CO2/0-9,000 KGS	0-70,000 Lbs CO2 / 0-35 TONS
0-200 IN H2O/0-5,080 MM H2O	0-70,000 LBS CO2/0-35 TONS
0-270 METRIC TONNES	0-700 IN H2O
0-28,000 LBS CO2	0-75 IN H2O/0-190 CM H2O
0-28,000 Lbs CO2 / 0-14,000 TONS	0-75 IN H2O/0-190 CM H2O
0-28,000 LBS CO2/0-12,800 KGS	0-76,000 LBS CO2/0-34,500 KGS
0-28,000 LBS H2O	0-8,000 LBS CO2 / 0-3,600 KGS

**Proof Pressure:**

Two times working pressure at ambient temperatures

**Temperature Limits:**

Gauge w/o/ switch -40°F to 200°F  
 Gauge with Snap Acting Switch -20°F to 185°F

These limits are based on the entire instrument being saturated to these temperatures. System (process) temperatures may exceed these limitations with proper installation. Contact our customer service representative for details.

**Standards:** Model 115/116 Series gauges either conform to and/or are designed to the requirements of the following standards:

ASME B1.20.1      CSA-C22.2 No.14      NEMA Std. No. 250  
 ASME B40.100      UL Std. No. 50      SAE J514

## Standard Model Specifications: 116-BB-10-(AP)O

500 PSIG Working Pressure, Brass Body, Stainless Steel Bellows, Stainless Steel Internals  
 Viton Seals, 1/4" FNPT Dual Top & Bottom Process Connections, 6" Uni-Directional Round Dial,  
 Brass snubber fittings mounted in bottom process connections, Panel mount gauge front  
 Weather Resistant Engineered Plastic Case with Shatter Resistant Acrylic Lens,  
 Accuracy ±1% Full Scale (Ascending)

**Mid-West Instrument**

**1-800-648-5778**

**Range 115: 0-10" H2O to 0-69.9" H2O (0-125 mbar to 0-2.5 PSID)**

**Range 116: 0-70" H2O to 0-800" H2O (0-2.5 PSID to 0-30 PSID)**

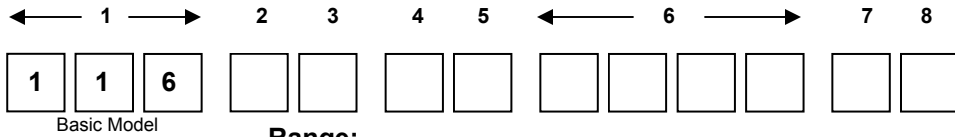

2	Material
B	500 PSIG, Brass Body, Stainless Steel Internals
Z	Special ( <i>Un-coded Options</i> )
3	Dial Size Type
B	Accuracy ±1% Full Scale Uni-Directional, White on Black Dial
W	Accuracy ±1% Full Scale Uni-Directional, Black on White Dial
Z	Special ( <i>Un-coded Options</i> )
4	Seal Materials
0	Buna-N
1	Viton®-A Registered Trademark of Dupont ( <b>Standard</b> )
5	Ethylene Propylene
9	Special ( <i>Un-coded Options</i> )
5	Process Connections / Orientation
0	1/4" FNPT Dual Top & Bottom (Hi port on the right side when facing the dial) ( <b>Standard</b> )
1	1/4" FNPT Dual Top & Bottom (Hi port on the left side when facing the dial)
9	Special ( <i>Un-coded Options</i> )
6	Additional Options
O	None
A	Brass snubber fittings mounted in bottom process connections ( <b>Standard</b> )
B	Brass snubber fittings mounted in top process connections
D	3/4" NPT S.S. Stub Mount Bracket
F	Carbon Steel 2" Pipe Mounting Kit
J	3-Valve S.S. Mini-Manifold #113343 mounted to bottom process connections ( <b>1/4" FNPT Connections</b> )
K	3-Valve S.S. Manifold #107470 mounted to bottom process connections ( <b>1/2" FNPT Connections</b> )
P	Panel Mount Kit
Q	CRN ( <b>Canadian Registration Number</b> )
S	Shatter Proof Glass Lens
T	Oxygen Cleaning
U	Stainless Steel Tag with S.S. Wire
Z	Special ( <i>Un-coded Options</i> )

## Standard Model Specifications – continued Model 115/116

7	Electrical Configurations
<b>O</b>	None
<b>A</b>	One (1) Switch in Weather Resistant Enclosure <b>Accuracy ±2% (Descending Pressure)</b>
<b>B</b>	Two (2) Switches in Weather Resistant Enclosure <b>Accuracy ±4%</b> 0-80" – 199" H2O only. (Descending Pressure) <b>Accuracy ±2%</b> 0-200" H2O and above.. (Descending Pressure)
<b>C</b>	One (1) Switch in Weather Resistant Housing with Condulet Enclosure <b>Accuracy ±2% (Descending Pressure)</b>
<b>D</b>	Two (2) Switches in Weather Resistant Housing with Condulet Enclosure <b>Accuracy ±4%</b> 0-80" – 199" H2O only. (Descending Pressure) <b>Accuracy ±2%</b> 0-200" H2O and above.. (Descending Pressure)
<b>Z</b>	Special ( <b>Un-coded Options</b> )
<b>Accuracies and repeatability values for 2 switch units are based upon one switch set low (approximately 25% for FSR) and one switch set High approx. 75% FSR).</b>	
8	Electrical Specifications
<b>A</b>	SPDT Micro Switch High Current Contact Ratings.(MAX): 4 Amps Maximum @ 30 VDC 3 Amps maximum @ 240 VAC 5 Amps @ 120 VAC
<b>Z</b>	Special ( <b>Un-coded Options</b> )
<b>Electrical Interface:</b> 18", 18 Awg, 600 V, 105°C / Color coded wire leads from 1/2" FNPT Connection Operating Temperature: -20° F to +185° F	
<b>Factory preset switches at no charge (specify setting)</b>	

### The Mid-West Instrument Advantage:

- “Engineered Plastic” gauge front and optional stainless steel body bolts provide superior corrosion resistance.
- Up to a 30 lb. weight savings over competitive range gauges
- Easier and less labor to panel mount
- Dry gauge design with no internal liquid fill
- No gauge damage/accuracy loss caused by liquid fill expansion/contraction when exposed to temperature shocks.
- Low range capability
- Industry best lead time reduces inventory requirements

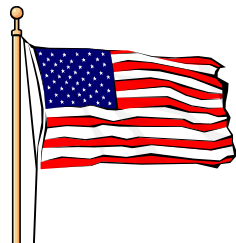

**MADE IN USA**

# FLOW MEASUREMENT PRODUCTS



MODEL 300

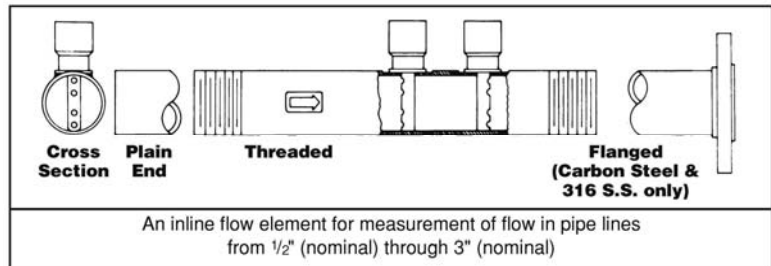

## PRECISION FLOW TEST KITS



For Installation and Operation Manuals  
Please Visit: [www.midwestinstrument.com/literature](http://www.midwestinstrument.com/literature)

**Mid-West**  
Instrument



# Mid-West<sup>®</sup> Instrument

## MODEL 805

### PRECISION FLOW TEST KIT

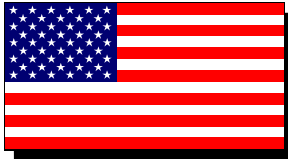

**Made In  
USA**



#### Functions & Applications:

High accuracy portable test kit for precise flow indication and leak detection. This kit is equipped with a precise ( $\pm 1\%$  of full scale) accuracy differential pressure gauge. Popular applications include but are not limited to: measuring the pressure drop across various types of equipment i.e. filters, balancing HVAC systems, checking pump performance, orifice plates, checking calibration of transmitters, or reading flow directly when ordered with a square root dial etc.

When being used the gauge should be placed in as nearly vertical position as possible. This gauge is position sensitive and accuracy may be less than stated, if not in a vertical position.

#### Product Features/Benefits:

- Over 30 Years of Input from Professional Testing Technicians
- Soft-Seated Brass Needle Valves (with replaceable valve seats)
- Test kit is protected with 90 micron filters to minimize plugging with scale, sand, etc. Filter elements can be cleaned or replaced
- Durable Molded Plastic Carrying Case with Removable lid
- Test Procedures are Laminated in Clear Plastic
- 5 Year Warranty

#### Specifications:

- Gauge Type: Bellows Differential Pressure
- Dial Size: 4-1/2" Standard (6" Optional)
- Range (4-1/2") 0-10" thru 0-79.9" H<sub>2</sub>O ranges available
- Accuracy:  $\pm 1\%$  Full Scale (Ascending) Std.  
(Accuracy:  $\pm 1/2\%$  Full Scale available)
- Working Pressure: 500 PSIG (Standard)
- Gauge Material: Aluminum Body & Copper Alloy Internals
- Wetted Internals: Buna-N Seals, Aluminum & Copper Alloy
- Hoses & End Fittings: Nitrile Jacket and liner. Schrader 1/4" brass coupler  
(Connects with 1/4" 37° Flare Male Fittings)
- Valves: Soft-Seated Brass
- Tubing & Fittings: Nylon & Brass
- Hose Length: 10' long (3 meter)
- Filters: 90 Micron Brass (Order Replacement Filter Kit No. 98008)
- Approximate Shipping Wgt: 15 lbs / 6.8 kg
- Case: Polyethylene
- Dimensional Data: 13.75" x 15.5" x 8.5"
- Temperature Limitations: Maximum 150°F/65°C  
**Freezing Temperatures must be avoided**

**Model 805 plumbed for water service only. Please contact the factory for assistance on kits for use with other liquids or gases.**

# Mid-West<sup>®</sup> Instrument

## MODEL 806

### PRECISION FLOW TEST KIT

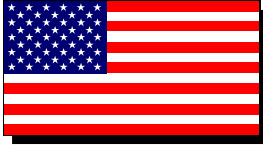

**Made In  
USA**



#### Functions & Applications:

High accuracy portable test kit for precise flow indication and leak detection. This kit is equipped with a precise ( $\pm 1\%$  of full scale) accuracy differential pressure gauge. Popular applications include but are not limited to: measuring the pressure drop across various types of equipment i.e. filters, balancing HVAC systems, checking pump performance, orifice plates, checking calibration of transmitters, or reading flow directly when ordered with a square root dial etc.

When being used the gauge should be placed in as nearly vertical position as possible. This gauge is position sensitive and accuracy may be less than stated, if not in a vertical position.

#### Product Features/Benefits:

- Over 30 Years of Input from Professional Testing Technicians
- Soft-Seated Brass Needle Valves (with replaceable valve seats)
- Test kit is protected with 90 micron filters to minimize plugging with scale, sand, etc. Filter elements can be cleaned or replaced
- Durable Molded Plastic Carrying Case with Removable lid
- Test Procedures are Laminated in Clear Plastic
- 5 Year Warranty

#### Specifications:

- Gauge Type: Bellows Differential Pressure
- Dial Size: 4-1/2" Standard (6" Optional)
- Range (4-1/2") 0-80" thru 0-400" H<sub>2</sub>O ranges available
- Differential Pressure Accuracy:  $\pm 1\%$  Full Scale (Ascending) Std.  
(Accuracy:  $\pm 1/2\%$  Full Scale available)
- Working Pressure: 500 PSIG (Standard)
- Gauge Material: Aluminum Body & Copper Alloy Internals
- Wetted Internals: Buna-N Seals, Aluminum & Copper Alloy
- Hoses & End Fittings: Nitrile Jacket and liner. Schrader 1/4" brass coupler  
(Connects with 1/4" 37° Flare Male Fittings)
- Valves: Soft-Seated Brass
- Tubing & Fittings: Nylon & Brass
- Hose Length: 10' long (3 meter)
- Filters: 90 Micron Brass (Order Replacement Filter Kit No. 98008)
- Approximate Shipping Wgt: 15 lbs / 6.8 kg
- Case: Polyethylene
- Dimensional Data: 13.75" x 15.5" x 8.5"
- Temperature Limitations: Maximum 150°F/65°C  
**Freezing Temperatures must be avoided**

***Model 806 plumbed for water service only. Please contact the factory for assistance on kits for use with other liquids or gases.***

# Mid-West<sup>®</sup> Instrument

## MODEL 809

### PRECISION FLOW TEST KIT

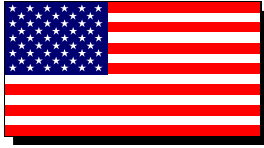

**Made In  
USA**



#### Functions & Applications:

High accuracy portable test kit for precise flow indication and leak detection. This kit is equipped with a precise ( $\pm 1\%$  of full scale) accuracy differential pressure gauge. Popular applications include but are not limited to: measuring the pressure drop across various types of equipment i.e. filters, balancing HVAC systems, checking pump performance, orifice plates, checking calibration of transmitters, or reading flow directly when ordered with a square root dial etc.

When being used the gauge should be placed in as nearly vertical position as possible. This gauge is position sensitive and accuracy may be less than stated, if not in a vertical position.

#### Product Features/Benefits:

- Over 30 Years of Input from Professional Testing Technicians
- Soft-Seated Brass Needle Valves (with replaceable valve seats)
- Test kit is protected with 90 micron filters to minimize plugging with scale, sand, etc. Filter elements can be cleaned or replaced
- Durable Molded Plastic Carrying Case with Removable lid
- Test Procedures are Laminated in Clear Plastic
- 5 Year Warranty

#### Specifications:

- Gauge Type: "Bourdon Tube" Differential Pressure
- Dial Size: 4-1/2" Standard (6" Optional)
- Range (4-1/2") 0-15 PSID thru 0-500 PSID ranges available
- Differential Pressure Accuracy:  $\pm 1\%$  Full Scale (Ascending) Std.  
(Accuracy:  $\pm 1/2\%$  Full Scale available)
- Working Pressure: 500 PSIG (Standard)
- Gauge Material: Aluminum Body & Copper Alloy Internals
- Wetted Internals: Buna-N Seals, Aluminum & Copper Alloy
- Hoses & End Fittings: Nitrile Jacket and liner. Schrader 1/4" brass coupler  
(Connects with 1/4" 37° Flare Male Fittings)
- Valves: Soft-Seated Brass
- Tubing & Fittings: Nylon & Brass
- Hose Length: 10' long (3 meter)
- Filters: 90 Micron Brass (Order Replacement Filter Kit No. 98008)
- Approximate Shipping Wgt: 15 lbs / 6.8 kg
- Case: Polyethylene
- Dimensional Data: 13.75" x 15.5" x 8.5"
- Temperature Limitations: Maximum 150°F/65°C  
**Freezing Temperatures must be avoided**

**Model 809 plumbed for water service only. Please contact the factory for assistance on kits for use with other liquids or gases.**



# Mid-West<sup>®</sup> Instrument

## MODEL 820 PRECISION FLOW TEST KIT

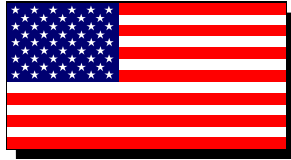

**Made In  
USA**



### Functions & Applications:

Rugged Medium Duty Portable Test Kit. This test kit is equipped with a  $\pm 3-2-3\%$  of full scale accuracy (ascending) piston type differential pressure gauge. Popular applications include but are not limited to, measuring pressure drop across various types of equipment, filters, checking pump performance, balancing valves, checking equipment for excessive pressure drop, leakage, etc.

### Product Features/Benefits:

- Over 30 Years of Input from Professional Testing Technicians
- Test kit is protected with 90 micron filters to minimize plugging with scale, sand, etc. Filter elements can be cleaned or replaced
- Durable Molded Plastic Carrying Case
- Test Procedures are Laminated in Clear Plastic
- 5 Year Warranty

### Specifications:

- Gauge Type: "Piston" Differential Pressure
- Dial Size: 2-1/2"
- Range: 0-10 PSID thru 0-100 PSID ranges available
- Accuracy:  $\pm 3-2-3\%$  Full Scale (Ascending)
- Working Pressure: 500 PSIG (Standard)
- Gauge Material: Aluminum Body & 316 S.S. Internals
- Wetted Internals: Buna-N Seals, Aluminum & 316 Stainless Steel
- Hoses & End Fittings: Nitrile Jacket and liner. Schrader 1/4" brass coupler (Connects with 1/4" 37° Flare Male Fittings).
- Tubing & Fittings: Nylon & Brass
- Hose Length: 5' long (1.5 meter)
- Filters: 90 Micron Brass (Order Replacement Filter Kit No. 98008)
- Approximate Shipping Wgt: 3.5 lbs / 1.6 kg
- Case: Polyethylene
- Dimensional Data: 12.25" x 6" x 7"
- Temperature Limitations: Maximum 150°F/65°C  
**Freezing Temperatures must be avoided**

# Mid-West<sup>®</sup> Instrument

## MODEL 831 PRECISION FLOW TEST KIT

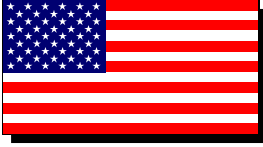

**Made In  
USA**



### Functions & Applications:

Sensitive yet rugged medium duty portable test kit. This test kit is equipped with a  $\pm 3-2-3\%$  of full scale accuracy (ascending) diaphragm type differential pressure gauge. Ideally suited for applications where differential pressures of 0-5" to 0-400" H<sub>2</sub>O may be encountered. Popular applications are balancing heating & cooling systems, checking pump performance, leakage, checking equipment for excessive pressure drop, (i.e. filters, balancing valves, averaging pitot tubes, orifice plates etc.) Dials may be for reading differential pressure, or reading flow directly if ordered with a flow (square root) dial.

### Product Features/Benefits:

- Over 30 Years of Input from Professional Testing Technicians
- Soft-Seated Brass Needle Valves (with replaceable valve seats)
- Test kit is protected with 90 micron filters to minimize plugging with scale, sand, etc. Filter elements can be cleaned or replaced
- Durable Molded Plastic Carrying Case with Removable lid
- Test Procedures are Laminated in Clear Plastic
- 5 Year Warranty

### Specifications:

- Gauge Type: "Diaphragm" Differential Pressure
- Dial Size: 4-1/2"
- Range: 0-10" H<sub>2</sub>O thru 0-400" H<sub>2</sub>O ranges available
- **Accuracy:**  $\pm 5\%$  Full Scale (Ascending) 0-5" H<sub>2</sub>O thru 0-9.9" H<sub>2</sub>O  
 $\pm 2\%$  Full Scale (Ascending) 0-10" H<sub>2</sub>O thru 0-400" H<sub>2</sub>O
- Working Pressure: 300 PSIG (Standard)
- Gauge Material: Engineered Plastic Body & 316 S.S. Internals
- Wetted Internals: Buna-N Seal & Diaphragm, Plastic, Aluminum & S.S., Brass
- Hoses & End Fittings: Nitrile Jacket and liner. Schrader 1/4" brass coupler **(Connects with 1/4" 37° Flare Male Fittings).**
- Valves: Soft-Seated Brass
- Tubing & Fittings: Nylon & Brass
- Hose Length: 10' long (3.0 meter)
- Filters: 90 Micron Brass **(Order Replacement Filter Kit No. 98008)**
- Approximate Shipping Wgt: 12 lbs / 5.5 kgs
- Case: Polyethylene
- Dimensional Data: 13.75" x 15.5" x 8.5"
- Temperature Limitations: Maximum 150°F/65°C  
**Freezing Temperatures must be avoided**

# Mid-West<sup>®</sup> Instrument

## MODEL 841 PRECISION FLOW TEST KIT

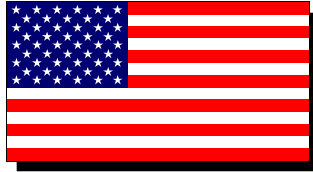

Made In  
USA



### Functions & Applications:

Rugged Medium Duty Portable Test Kit. This test kit is equipped with a  $\pm 3-2-3\%$  of full scale accuracy (ascending) diaphragm type differential pressure gauge. Popular applications include but are not limited to, measuring pressure drop across various types of equipment, filters, checking pump performance, balancing valves, checking equipment for excessive pressure drop, leakage, etc.

### Product Features/Benefits:

- Over 30 Years of Input from Professional Testing Technicians
- Test kit is protected with 90 micron filters to minimize plugging with scale, sand, etc. Filter elements can be cleaned or replaced
- Durable Molded Plastic Carrying Case
- Test Procedures are Laminated in Clear Plastic
- 5 Year Warranty

### Specifications:

- Gauge Type: "Diaphragm" Differential Pressure
- Dial Size: 2-1/2"
- Range: 0-50" H<sub>2</sub>O thru 0-100 PSID ranges available
- Differential Pressure Accuracy:  $\pm 5\%$  Full Scale (Ascending) 0-50" thru 0-399.9" H<sub>2</sub>O  
 $\pm 3-2-3\%$  Full Scale (Ascending) 0-400" H<sub>2</sub>O thru 0-100 PSID
- Working Pressure: 500 PSIG (Standard)
- Gauge Material: Aluminum Body & 316 S.S. Internals
- Wetted Internals: Buna-N Seal & Diaphragm, Aluminum & 316 Stainless Steel
- Hoses & End Fittings: Nitrile Jacket and liner. Schrader 1/4" brass coupler (Connects with 1/4" 37° Flare Male Fittings).
- Tubing & Fittings: Nylon & Brass
- Hose Length: 5' long (1.5 meter)
- Filters: 90 Micron Brass (Order Replacement Filter Kit No. 98008)
- Approximate Shipping Wgt: 8 lbs / 3.6 kgs
- Case: Polyethylene
- Dimensional Data: 12.25" x 6" x 7"
- Temperature Limitations: Maximum 150°F/65°C  
**Freezing Temperatures must be avoided**

# Mid-West<sup>®</sup> Instrument

## MODEL 842 PRECISION FLOW TEST KIT

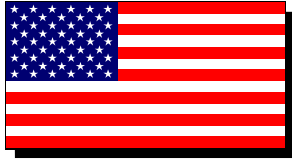

**Made In  
USA**



### Functions & Applications:

Rugged (2) gauge medium duty portable flow test kit. This kit is equipped with two differential pressure gauges with complimentary dial ranges, enabling it to cover a broad range of differential pressures with accuracies of  $\pm 3-2-3\%$  full scale (ascending). Both gauges are protected against over-range to the maximum working pressure of the test kit. While primarily used for balancing HVAC systems it has numerous other applications which include but are not limited to: checking pump performance, checking pressure drop across filters, leakage, etc...

### Product Features/Benefits:

- Over 30 Years of Input from Professional Testing Technicians
- Combination kit includes both 820 & 841 Flow test gauges
- Test kit is protected with 90 micron filters to minimize plugging with scale, sand, etc. Filter elements can be cleaned or replaced
- Durable Molded Plastic Carrying Case
- Test Procedures are Laminated in Clear Plastic
- 5 Year Warranty

### Specifications:

- Gauge Type: **(1)** "Piston" & **(1)** "Diaphragm" Differential Pressure
- Dial Size: **(2)** 2-1/2"
- Range: 0-50" H<sub>2</sub>O thru 0-100 PSID ranges available
- Differential Pressure Accuracy:  $\pm 3-2-3\%$  Full Scale (Ascending) 0-50" H<sub>2</sub>O thru 0-100 PSID
- Working Pressure: 500 PSIG (Standard)
- Gauge Material: **(2)** Aluminum Body & 316 S.S. Internals
- Wetted Parts: Buna-N Seal & Diaphragm, Brass, Aluminum & 316 Stainless Steel
- Hoses & End Fittings: Nitrile Jacket and liner. Schrader 1/4" brass coupler **(Connects with 1/4" 37° Flare Male Fittings).**
- Tubing & Fittings: Nylon & Brass
- Hose Length: 5' long (1.5 meter)
- Filters: 90 Micron Brass **(Order Replacement Filter Kit No. 98008)**
- Approximate Shipping Wgt: 10 lbs / 4.5 kg
- Case: Polyethylene
- Dimensional Data: 12.25" x 6" x 7"
- Temperature Limitations: Maximum 150°F/65°C  
**Freezing Temperatures must be avoided**

# Mid-West<sup>®</sup> Instrument

## MODEL 843 PRECISION FLOW TEST KIT

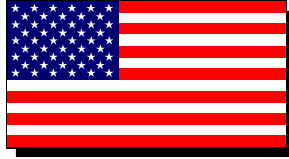

**Made In  
USA**



### Functions & Applications:

Rugged (2) gauge medium duty portable flow test kit. This kit is equipped with two differential pressure gauges with complimentary dial ranges, enabling it to cover a broad range differential pressures and accuracies of  $\pm 3-2-3\%$  full scale (ascending). Both gauges are protected against over-range to the maximum working pressure of the test kit. While primarily used for balancing HVAC systems it has numerous other applications which include but are not limited to: checking pump performance, checking pressure drop across filters, leakage, etc...

### Product Features/Benefits:

- Over 30 Years of Input from Professional Testing Technicians
- Combination kit includes both 831 & 841 Flow test gauges
- Test kit is protected with 90 micron filters to minimize plugging with scale, sand, etc. Filter elements can be cleaned or replaced.
- Durable Molded Plastic Carrying Case
- Test Procedures are Laminated in Clear Plastic
- 5 Year Warranty

### Specifications:

- Gauge Type: **(2)** "Diaphragm" Differential Pressure
- Dial Size: **(2)** 4-1/2"
- Range: 0-10" H<sub>2</sub>O thru 0-100 PSID ranges available
- Pressure Accuracy:  $\pm 5\%$  Full Scale (Ascending) 0-10" H<sub>2</sub>O thru 0-400" H<sub>2</sub>O
- $\pm 3-2-3\%$  Full Scale (Ascending) 0-400" H<sub>2</sub>O thru 0-100 PSID
- Working Pressure: 300 PSIG (Standard)
- Gauge Material: **(1)** Engineered Plastic Body **(1)** Aluminum Body & 316 S.S. Internals
- Wetted Internals: Buna-N Seal & Diaphragm, Plastic, Aluminum & S.S., Brass
- Hoses & End Fittings: Nitrile Jacket and liner. Schrader 1/4" brass coupler **(Connects with 1/4" 37° Flare Male Fittings)**.
- Tubing & Fittings: Nylon & Brass
- Hose Length: 5' long (1.5 meter)
- Filters: 90 Micron Brass **(Order Replacement Filter Kit No. 98008)**
- Approximate Shipping Weight: 12 lbs / 5.5 kgs
- Case: Polyethylene
- Dimensional Data: 16.5" x 7.25" x 9"
- Temperature Limitations: Maximum 150°F/65°C  
**Freezing Temperatures must be avoided**

# Mid-West<sup>®</sup> Instrument

MID-WEST INSTRUMENT HAS A FLOW SCALE FOR YOU.



Typical Flow Dial

Flow measurement using Mid-West Instrument differential pressure gauge technology will provide accuracy and reliability you've come to know and trust. Our industrial quality differential pressure flow gauge uses modern materials and current technology to provide an easy to read flow scale.

Mid-West differential pressure flow gauges indicate such flow rates as liters per minute up to gallons per hour, even when used at high line pressures. Units can be supplied with reed switches or relays to initiate alarms, activate other equipment, or shut the system down. Two switches are available when high and low limits are required. 4-20 mA Transmitter also available.

Here are some typical flow designators: **GPM, USGPM, ACFM, SCFM, NM<sup>3</sup>/HR, LBS/HR, L/MIN, L/SEC, KG/HR, TONS/HR.** Flow scale dials are available for the following Mid-West differential pressure gauges: Model 105, 106, 109, 130, 140 and 142



**Model 105/106** Range: 0-10" H<sub>2</sub>O to 0-400" H<sub>2</sub>O (25 mbar to 1 bar)  
**Model 109** DP Range: 0-15 PSID (0-1.0 bar) to 0-6000 PSID (0-400 bar)  
**± 1/2% or ± 1% Full Scale Accuracy**  
Uni-Directional Dial Ranges are available in either  
LINEAR or SQUARE ROOT FLOW SCALES



## AVAILABLE FLOW SCALES MODELS: 105, 106, & 109

Uni-Directional Dial Ranges are available in either LINEAR or SQUARE ROOT FLOW SCALES with any appropriate legend ( I.E. GPM, SCFM, USGPM, NM3/HR, L/MIN, ETC) at no extra charge			LINEAR Bi-Directional Dials are available with any appropriate Legend at No Charge		
0-0.5	0-30		0-300	1.0-0-1.0	75-0-75
0-1.0	0-35		0-400	2.0-0-2.0	100-0-100
0-1.6	0-40		0-500	5.0-0-5.0	150-0-150
0-2.0	0-50		0-600	10-0-10	200-0-200
0-3.0	0-60		0-700	15-0-15	300-0-300
0-4.0	0-70		0-800	25-0-25	400-0-400
0-5.0	0-75		0-900	30-0-30	750-0-750
0-6.0	0-80		0-1000	50-0-50	1000-0-1000
0-7.0	0-100		0-1500		
0-8.0	0-135		0-1600		
0-10	0-150		0-2000		
0-15	0-160		0-3000		
0-20	0-200		0-4000		
0-25	0-250		0-5000		
			0-6000		



### Model 130

Range: 0-5" H2O to 0-400" H2O

**0-5" to 0-9.9" H2O ± 5%**

**0-10" to 0-400" H2O ± 2%**

**Full Scale Accuracy**

### Model 140 or 142

142 Range:

**0-20" H2O to 0-25 PSID**

140 Range:

**0-25 PSID to 0-100 PSID**

**± 2% Full Scale Accuracy**

Uni-Directional Dial Ranges are available in either LINEAR or SQUARE ROOT FLOW SCALES

## AVAILABLE FLOW SCALES MODELS: 130, 140, 142

Uni-Directional Dial Ranges are available in either LINEAR or SQUARE ROOT FLOW SCALES with any appropriate legend (I.E.GPM, SCFM, USGPM, NM3/HR, L/MIN, ETC) at no extra charge		
Model 130 Flow Dials		Models 140/142 Flow Dials
0-1.0		0-1.0
0-1.25		0-1.5
0-1.5		0-2.0
0-1.75		0-2.5
0-2.0		0-5.0
0-2.5		0-10.0
0-3.0		
0-3.5		
0-4.0		
0-4.5		
0-5.0		
0-5.5		
0-6.0		
0-6.5		
0-7.0		
0-7.5		
0-8.0		
0-8.5		
0-9.0		
0-9.5		
0-10		

**Available Multipliers for Flow Dials: X10, X100, X1000, and X10,000**

**Note: Not all ranges available in all diaphragm materials**

## MODEL 300

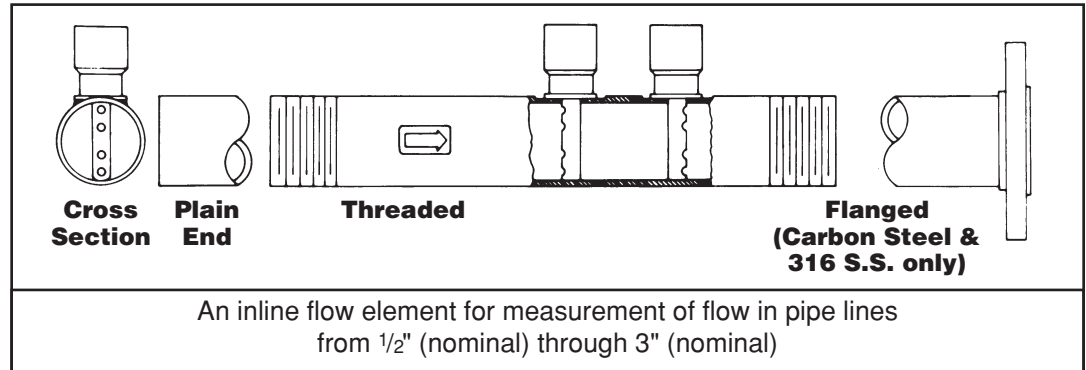

### Functions & Applications:

### Specifications:

Materials		Carbon Steel (a)		316 Stainless Steel (b)		CPVC Solvent Welded
Pipe Size		1/2", 3/4", 1", 1 1/2", 2", 2 1/2", 3"				1/2", 3/4", 1", 1 1/2", 2", 2 1/2", 3" Schedule 80 only
End Connections		Threaded	Welded	Threaded	Welded	Threaded - Standard Plain End - Optional
Working Pressure (PSIG) Carbon Steel Based on -20 to 600°F 316 S.S. Based on -20 to 200°F CPVC (Water Service) Up to 73.4°F (23°C) For other media and/or temperatures, see Engineering Data.	<b>Pipe Size</b>	<b>Schedule 40</b>	<b>Schedule 40</b>	<b>Schedule 40</b>	<b>Schedule 40</b>	<b>Schedule 80</b>
	1/2	1320	2950	2080	4640	300
	3/4	1130	2400	1770	3770	240
	1	1020	2240	1600	3520	220
	1 1/2	830	1660	1310	2600	170
	2	740	1390	1170	2190	140
	2 1/2	750	1530	1180	2400	150
	3	690	1320	1080	2080	130
<b>NOTES:</b>		For flange applications, see ASME/ANSI B16.5 or Mid-West Bulletin No. ASDE/Latest. (a) Pressures & Temperatures are based on ASTM A53 Grade A Welded Schedule 40 Carbon Steel Pipe. (b) Pressures & Temperatures are based on ASTM A 312 TP 316 Welded Schedule 40 Stainless Steel Pipe. For additional System Pressure (PSIG) vs Temperature (°F) see Mid-West Bulletin No. ASDE/Latest.				
Instrument Connections		1/4" FNPT (Standard), 1/2" (Optional for C.S. or S.S. only)				

### Special Features:

Utilizes two averaging flow elements of equal area to sense stagnation (RAM) and static differential pressure providing minimum permanent pressure loss.

### Related Products Available:

Indicators & Switches	A broad selection of indicators, with or without switching, are available. For details, please refer to Mid-West Bulletins on Models 105 & 130.
Portable Indicators	A wide variety of portable indicators are also available. Please see Mid-West Bulletin 800/Latest.



# Part Numbering System

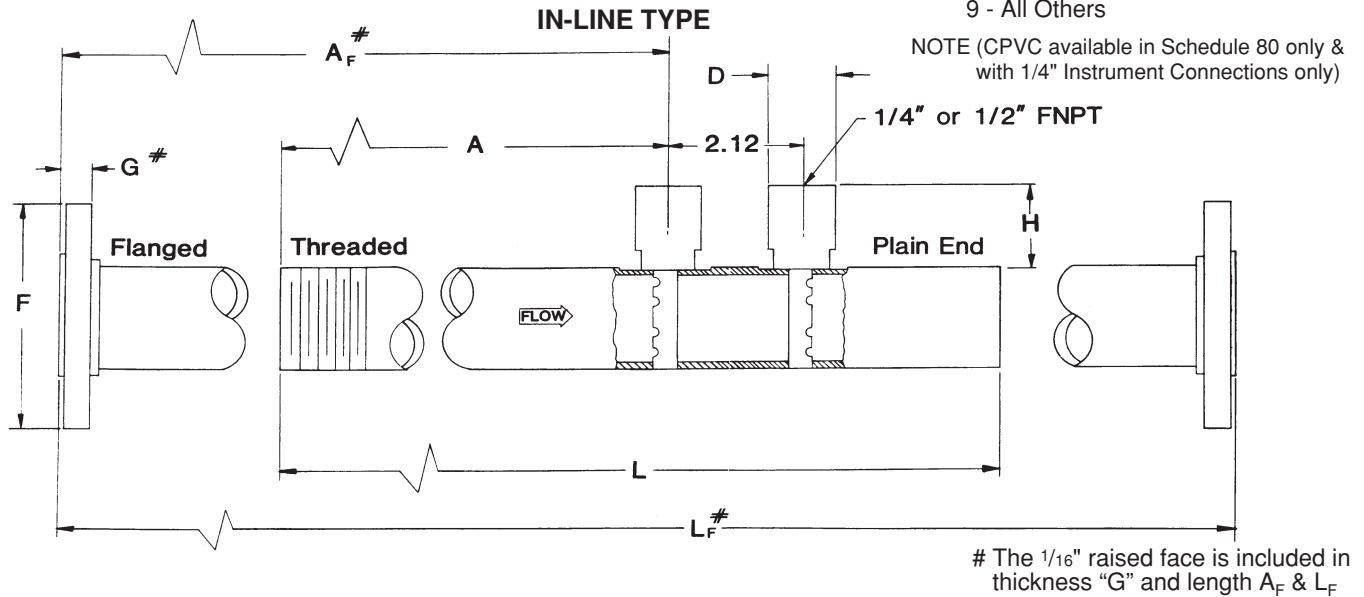
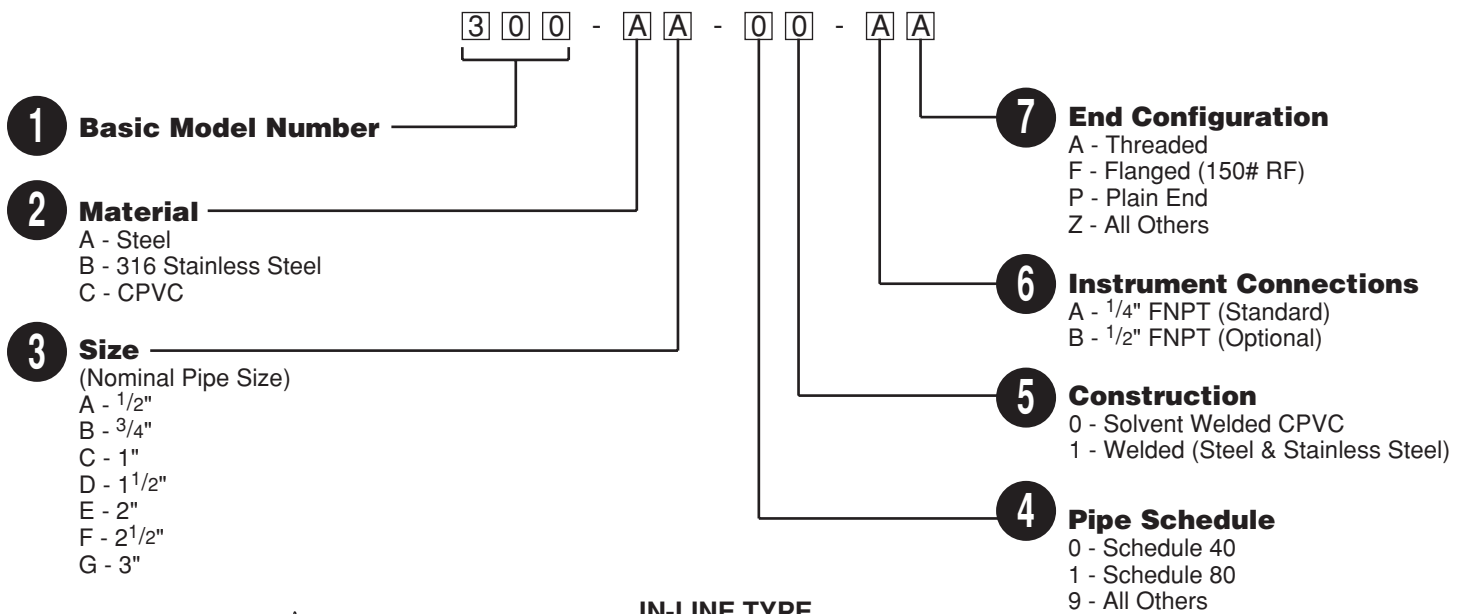

## Dimensional Data

Manufacturer reserves the right to change specifications without prior notice.

Pipe Size (Nominal)	L	A	$A_F$	H	D		F	G	$L_F$
				(Max.)	1/4" FNPT	1/2" FNPT		Flanged Only*	
1/2"	6"	23/16"	27/16"	1.38			3.5	.44	6.62
3/4"	6"	23/16"	23/8"	1.38			3.88	.50	6.53
1"	8"	311/16"	37/8"	1.38			4.25	.56	8.5
1 1/2"	8"	311/16"	315/16"	1.38	.75	1.12	5.0	.69	8.63
2"	10"	415/16"	51/4"	1.38			6.0	.75	10.75
2 1/2"	10"	415/16"	55/16"	1.38			7.0	.88	10.87
3"	12"	515/16"	65/16"	1.38			7.5	.94	13.0

\* Dimensions are for socket weld flanges (150 lb.). For other flange ratings consult factory.

# Mid-West®

## Instrument

6500 Dobry Dr. □ Sterling Heights, MI 48314  
 (586) 254-6500 □ FAX (586) 254-6509  
 E-mail: sales@midwestinstrument.com  
 Website: www.midwestinstrument.com

REPRESENTED BY

# O.E.M GAUGES

---



For Installation and Operation Manuals  
Please Visit: [www.midwestinstrument.com/literature](http://www.midwestinstrument.com/literature)

---

**Mid-West**  
Instrument



# Mid-West<sup>®</sup> Instrument

## O.E.M “Piston Type” Differential Pressure Gauges & Switches Models 126 & 127



### Common Applications

- Filter Monitoring
- Strainer Monitoring
- Water System Applications
- Refrigerant Filtration Systems

### 126/127 Specifications:

- (126) Differential Pressure Range 0-5 PSID (0-0.35 bar) to 0-20 PSID (0-1.4 bar)
- (127) Differential Pressure Range 0-25 PSID (0-1.7 bar) to 0-100 PSID (0-7 bar)
- Accuracy  $\pm 5\%$  Full Scale Ascending
- Dial Size
  - Single 1-1/4" x 2-1/4" Oval (Std.)
  - Dual 1-1/4" x 2-1/4" Oval (Opt.)
- Working Pressure 3,000 PSIG (200 bar)
- Operating Temp. -40° F To +200° F (-40°C to 93°C)
- Body Material - Aluminum (Std.), 316/316L SS (Opt.)
- Internal Materials - 316 Stainless Steel
- Elastomers - Buna-N (Std), Viton<sup>®</sup>\* , Neoprene, Ethylene-Propylene,
- Switch Option
  - SPDT 3W, 125 VAC/VDC, 0.25 Amp
  - SPST 60W, 240 VAC/VDC, 3 Amp
- Switch Mounting Clamp On, Stick On Flat Pack
- Process Connections 1/8" FNPT Bottom (Std) 1/8" FNPT End Conn. (Opt.)
- Dimensions 1.25H" x 1.62W" x 2.48L"
- Weight 0.5#

\* Viton<sup>®</sup> is a Registered Trademark of DuPont Dow Elastomers

Model 126/127 Bottom  
Connections Shown



**Model "126"** 3000 PSIG Working Pressure, S.S. Piston, Aluminum or S.S. Body & End Plug,  
Accuracy  $\pm 5\%$  F.S. (Ascending), 1/8" FNPT Bottom Mount,  
Range: **0-5 PSID thru 0-20 PSID**

**Model "127"** 3000 PSIG Working Pressure, S.S. Piston, Aluminum or S.S. Body & End Plug,  
Accuracy  $\pm 5\%$  F.S. (Ascending), 1/8" FNPT Bottom Mount, Range:  
**0-25 PSID thru 0-100 PSID**

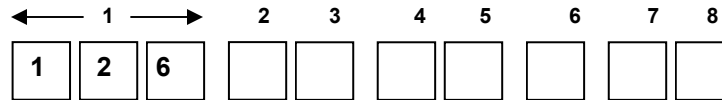

<b>2</b>	<b>Material</b>
<b>A</b>	Aluminum Body / Stainless Steel Piston
<b>S</b>	316 S.S Body / Stainless Steel Piston
<b>Z</b>	Special ( <i>Un-coded Options</i> )
<b>3</b>	<b>Dial Size &amp; Type</b>
<b>W</b>	One
<b>X</b>	Two
<b>Z</b>	Special ( <i>Un-coded Options</i> )
<b>4</b>	<b>Seal Materials</b>
<b>0</b>	Buna-N
<b>1</b>	Viton®-A Registered Trademark of Dupont
<b>2</b>	Neoprene
<b>5</b>	Ethylene Propylene
<b>9</b>	Special ( <i>Un-coded Options</i> )
<b>5</b>	<b>Process Connections</b>
<b>0</b>	1/8" FNPT Bottom Connections
<b>2</b>	1/8" FNPT End Connections
<b>9</b>	Special ( <i>Un-coded Options</i> )
<b>6</b>	<b>Options</b>
<b>O</b>	None
<b>Z</b>	Special ( <i>Un-coded Options</i> )
<b>7</b>	<b>Electrical Configuration</b>
<b>A</b>	(1) Switch (clamp-on) Switch adjustable range 10 to 100%
<b>B</b>	(2) Switches (clamp-on) Switch adjustable range 10 to 100%
<b>C</b>	(1) Switch (Flat Pack) Non-Adjustable
<b>D</b>	(1) Switches (Flat Pack) Non-Adjustable
<b>E</b>	(1) Switch (clamp-on) Switch adjustable range $\pm 15\%$
<b>F</b>	(2) Switches (clamp-on) Switch adjustable range $\pm 15\%$
<b>Z</b>	Special ( <i>Un-coded Options</i> )
<b>8</b>	<b>Electrical Specifications</b>
<b>A</b>	SPDT 3W .025 Amp 125 VAC/VDC (Flat-Pack)
<b>C</b>	SPST 60W 3.0 Amp 240 VAC/VDC (Clamp-On & Flat-Pack)
<b>Z</b>	Special ( <i>Un-coded Options</i> )

**\* Special "OEM" Box car number will be assign upon order.**

**\*Gauges must be purchased in quantities of 25 units.**

# Mid-West<sup>®</sup> Instrument

## O.E.M “Diaphragm Type” Differential Pressure Gauge & Switch Model 146

### Common Applications



- Filter monitor for initiating backwash cycles
- Strainer Monitoring
- Water Systems applications
- Hydro applications
- Pump performance monitoring
- Refrigerant filtration systems
- Replacement indicating switch for competitor switches that do not offer local indication

### Specifications:

- Differential Pressure 0-50" H<sub>2</sub>O (0-125 mbar) to 0-30 PSID (0-2.0 bar)
- Accuracy ±5% Full Scale Ascending
- Dial Size
  - Single 1-1/4" x 2-1/4" Oval (Std.)
  - Dual 1-1/4" x 2-1/4" Oval (Opt.)
- Working Pressure 1,000 PSIG (200 bar)
- Operating Temp. -40° F To +200° F (-40°C to 93°C)
- Body Material – Aluminum, Brass & 316L Stainless Steel
- Internal Materials - 316 Stainless Steel
- Elastomers - Buna-N (Std), Viton<sup>®</sup>\* , Silicone, Neoprene (25 PSID & Below), Ethylene Propylene
- Switch Option
  - SPDT 3W, 125 VAC/VDC, 0.25 Amp
  - SPST 60W, 240 VAC/VDC, 3 Amp
- Process Connections 1/8" FNPT Bottom
- Dimensions 1.7H" x 2.5W" x 2.9L"
- Weight 2.5#



\* Viton<sup>®</sup> is a Registered Trademark of DuPont Dow Elastomers

**Operation:** Differential pressure is sensed by flexible elastomer diaphragm and a calibrated spring. A magnetic coupling transmits the sensing element motion to an indicating pointer. This prohibits the possibility of fluid leaking into the gauge case, while assuring total isolation of the process fluid within the pressure capsule. The diaphragm assures total separation between high and low pressure signals. It is totally supported at full travel in either direction.

**Temperature Limits:** -40 °F (-40° C) to 200°F (93°C). These limits are based on the entire instrument being saturated to these temperatures. System (process) temperatures may exceed these limitations with proper installation. Contact our customer service representative for details.

**Model "146"** 1000 PSIG Working Pressure, Buna-N Diaphragm,  
Aluminum, Brass or 316 Stainless Steel Body, 316 S.S. Internal Metal Parts  
Accuracy  $\pm 5\%$  F.S. (Ascending), 1/8" FNPT Bottom Mount  
Range: **0-50" H<sub>2</sub>O** thru **0-30 PSID**

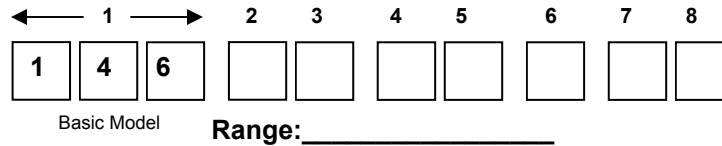

<b>2</b>	<b>Material</b>
<b>A</b>	Aluminum Body
<b>B</b>	Brass Body
<b>S</b>	316 Stainless Steel Body
<b>Z</b>	Special ( <i>Un-coded Options</i> )
<b>3</b>	<b>Dial Size &amp; Type</b>
<b>W</b>	One
<b>X</b>	Two
<b>Z</b>	Special ( <i>Un-coded Options</i> )
<b>4</b>	<b>Seal Materials</b>
<b>0</b>	Buna-N
<b>1</b>	Viton®-A Registered Trademark of Dupont
<b>2</b>	Silicone
<b>4</b>	Neoprene ( <i>25 PSID &amp; below</i> )
<b>5</b>	Ethylene Propylene
<b>9</b>	Special ( <i>Un-coded Options</i> )
<b>5</b>	<b>Process Connections</b>
<b>0</b>	1/8" FNPT Bottom Connections ( <b>STD</b> )
<b>2</b>	1/8" FNPT Back Connections
<b>6</b>	<b>Options</b>
<b>O</b>	None
<b>Z</b>	Special ( <i>Un-coded Options</i> )
<b>7</b>	<b>Electrical Configuration</b>
<b>A</b>	(1) Switch (non-adjustable)
<b>B</b>	(2) Switches (non-adjustable)
<b>C</b>	(1) Switch (non-adjustable) DIN Plug-In Connector
<b>D</b>	(1) Switch (Flat Pack) Non-Adjustable
<b>E</b>	(2) Switches (Flat Pack) Non-Adjustable
<b>F</b>	(1) Switch (Flat Pack) Switch adjustability $\pm 15\%$
<b>G</b>	(2) Switches (Flat Pack) Switch adjustability $\pm 15\%$
<b>Z</b>	Special ( <i>Un-coded Options</i> )
<b>8</b>	<b>Electrical Specifications</b>
<b>A</b>	SPDT 3W .025 Amp 125 VAC/VDC (Flat-Pack)
<b>C</b>	SPST 60W 3.0 Amp 240 VAC/VDC (Clamp-On & Flat-Pack)
<b>Z</b>	Special ( <i>Un-coded Options</i> )

\*\*Product of switching voltage and current shall not exceed the power rating. Ratings are resistive loads.

**\* Special "OEM" Box car number will be assign upon order.**

**\*Gauges must be purchased in quantities of 25 units.**

# Mid-West<sup>®</sup> Instrument

## O.E.M “Piston Type” Differential Pressure Indicator Model 444

Model 444 Series differential pressure indicator offers a simple, yet functional design for use with filters, strainers, etc. This low cost indicator makes the perfect alternative to more costly differential pressure gauges where readability, small size and price are important considerations.

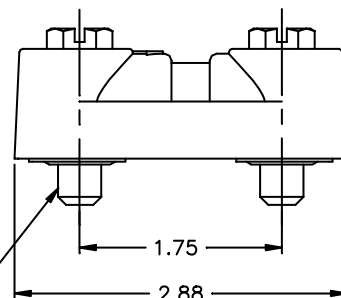
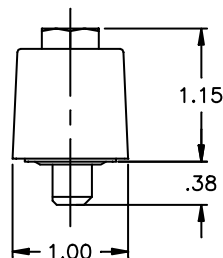

All dimensions in inches.

FLAT AREA OF .625 DIA.  
MINIMUM REQUIRED ON  
MOUNTING SURFACE—  
FOR BOTH BOLTS

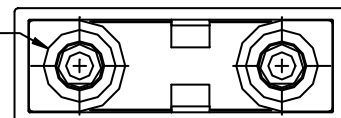

Made  
in the  
USA

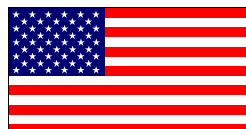

Model Number	DP Range	Transition Points	
		Piston Moves @	Indicator all Red @
444-05	0-5 PSID	3.75 PSI	5.25 PSI
444-10	0-10 PSID	7.75 PSI	10.5 PSI
444-15	0-15 PSID	11.75 PSI	15.5 PSI
444-25	0-25 PSID	18.75 PSI	27.0 PSI

Minimum Order Quantity  
**50 UNITS**

**OEM Applications Quoted**  
Please call with specifications.

SPECIFICATIONS:		Comments:
Maximum Working Pressure	300 PSIG	
Differential Pressure Ranges: **Contact factory for additional ranges	0-5 thru 0-25 PSID**	
Accuracy	± 5% of Rated Differential Pressure Range	Calibrated at Color Transitions
Operating Temperature (Max.)	93°C (200°F)	
MATERIALS OF CONSTRUCTION:		
Body Material	Glass Filled Nylon (GFN) 6/6 Body	
Wetted Internals	Glass Filled Nylon & Stainless Steel	
Elastomers	Buna-N	
Lens	Clear Nylon	
INTERFACE:		
Process Connection:	Slotted Hex Bolt 3/8-24 UNF Chamfered Bolts Ease Installation	Flow Direction Identified on Indicator Body. Arrow Points to Low Pressure Port.





# Mid-West<sup>®</sup> Instrument

## O.E.M “Diaphragm Type” Differential Pressure Indicator Model 555

Colored bands allow you to quickly identify pressure drop across element.  
Divided into three sections, each clearly marked for ease of understanding. Commonly used to indicate when to change or clean a filter. **Example:** 555A-10.0 changes from green to yellow at 5 PSID and from yellow to red at 7.5 PSID. Accuracy is  $\pm 5\%$  Full Scale

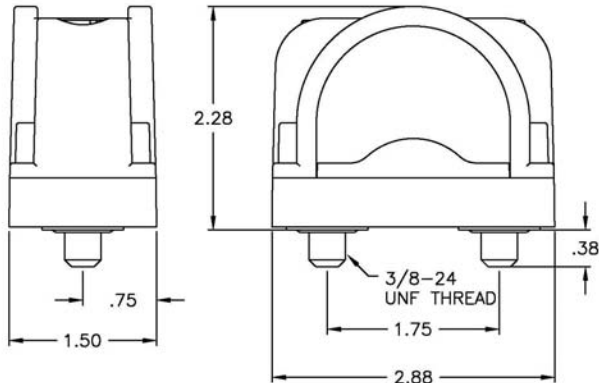

Model Number	DP Range	Transition Points		
		Green	Yellow	Red
555-3.5	0-3 PSID	0-2.0	2.0-2.5	2.5-3.5
555-5.0	0-5 PSID	0-3.0	3.0-4.5	4.5-5.0
555-10.0	0-10 PSID	0-5.0	5.0-7.5	7.5-10.0
555-12.0	0-12 PSID	0-6.0	6.0-9.0	9.0-12.0
555-15.0	0-15 PSID	0-7.5	7.5-12.0	12.0-15.0
555-25.0	0-25 PSID	0-11.0	11.0-18.5	18.5-25.0
555-30.0	0-30 PSID	0-13.0	13.0-20.0	20.0-30.0
555-43.0	0-43 PSID	0-19.5	19.5-29.5	29.5-43.0

**50 Pieces per Shipment Minimum Order Quantity**

**OEM applications quoted. Please call with specifications.**

SPECIFICATIONS:		Comments:
Pressure (Ratings)		
Maximum Working	300 PSIG	
Maximum Differential	150 PSID	
Accuracy	$\pm 5\%$ of Rated Differential Pressure Range	Calibrated at Color Transitions
Operating Temperature (Max.)	93°C (200°F)	
Materials of Construction		
Body Material	Glass Filled Nylon (GFN)	
Wetted Internals	Stainless Steel, Ceramic, & GFN	
Elastomers	Buna	
Movement	Magnetic Piston and Follower Pointer	
Dial	Plastic Lens with 3 Color Dial	
INTERFACE:		
Process Connection:	<p><b>1/4" FNPT End Connections.</b></p> <p>To switch HIGH and LOW pressure connections: Remove Indicator from base and rotate 180° - Retighten plastic bolts to 20-25 inch pounds.</p>	Flow Direction Identified on Dial. Arrow Points to Low Pressure Port.



# Mid-West<sup>®</sup> Instrument

## O.E.M “Diaphragm Type” Differential Pressure Gauges & Switches Model 522



**RANGE: 0-5 P.S.I.D. TO 0- 50 P.S.I.D. (.3 bar to 3.4 bar)**



### Gauge Features:

- Safe Working Pressure: 1000 PSIG (69 bar).
- Aluminum or 316 / 316L SS Gauge Body.
- Wetted Parts: 316 SS, Ceramic, & Acetal components
- Seal & Diaphragm Material: Buna-N or Viton
- 1/4" FNPT Process Connections (End Connected)
- Weather-resistant construction standard.
- Dial Accuracy  $\pm 5\%$  standard.
- Switch Only (No Dial) available
- Dial: 0.80" weatherproof multicolored
- 2-1/2" Optional Dial Size

### Switch Features:

- Switches are optional
- Hermetically Sealed Switch Outputs up to 3 amps in SPST and up to .25 Amp in SPDT configuration.
- Switch Adjustable from 40% - 95% of Range \*
- Up to 240 VAC/VDC voltage ratings
- Available with Flat Pack case with Jacketed Flying Leads or with DIN IP65 / NEMA 4X Plug-in Connector.
- Optional Switch Set Feedback Decal
- Switch Location Top or Bottom
- CE Marking for Compliance with the Low Voltage Directive is available upon request.
- \*Dependent on selected switch option.



**Operation:** Differential pressure is sensed by flexible elastomer diaphragm and a calibrated spring. A magnetic coupling transmits the sensing element motion to an indicating pointer. This prohibits the possibility of fluid leaking into the gauge case, while assuring total isolation of the process fluid within the pressure capsule. The diaphragm assures total separation between high and low pressure signals. It is totally supported at full travel in either direction.

**Temperature Limits:** -40 °F (-40° C) to 200°F (93°C). These limits are based on the entire instrument being saturated to these temperatures. System (process) temperatures may exceed these limitations with proper installation. Contact our customer service representative for details.

**Standards:** All Model 522 Series differential pressure gauges either conform to and/or are designed to the requirements of the following standards: ASME B1.20.1 NACE MR0175, ASME B40.100 NEMA Std. 250, EN-61010-1 UL Std. No. 50 & 508, CSA-C22.2 No. 14

**Factory Preset of switches available at no charge (Specify switch setting on the order)  
The use of diaphragm seals is not recommended.  
Attempts to install such seals on this gauge will void the warranty**

## Ordering Information:

Contact factory for desired configuration options & pricing.

## Dimensional:

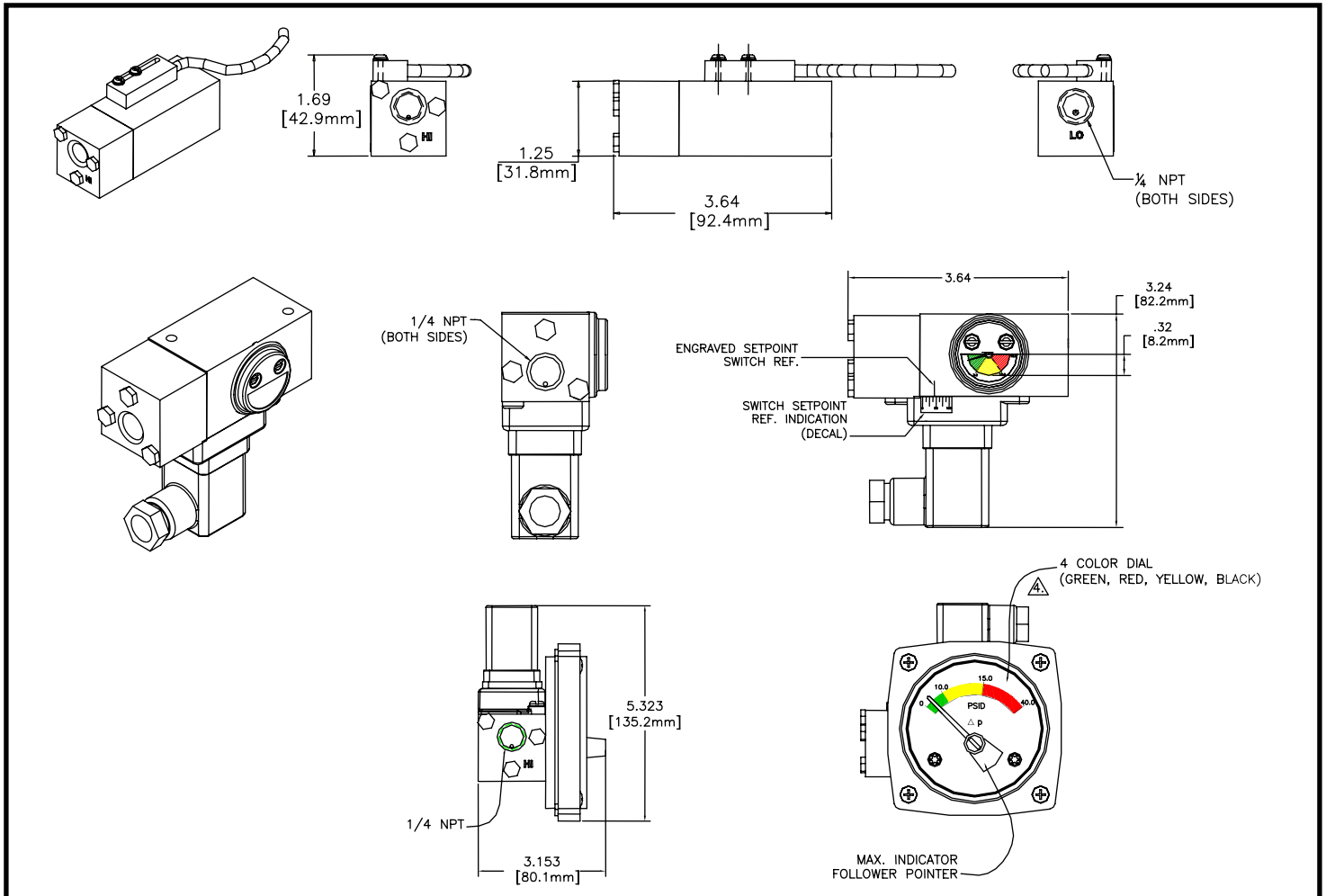

**TEMPERATURE LIMITS:** -40 F (-40 C) to 200 F (93 C). These limits are based on the entire instrument being saturated to these temperatures. System (process) temperatures may exceed these limitations with proper installation. Contact our customer service representative for details.

**STANDARDS:** All Model 522 Series differential pressure gauges either conform to and/or are designed to the requirements of the following standards:

ASME B1.20.1      NACE MR0175  
ASME B40.100      NEMA Std. 250  
EN-61010-1      UL Std. No. 50 & 508  
CSA-C22.2 No. 14

**Factory Preset of switches available at no charge (Specify Setting on the order)**

**The use of diaphragm seals is not recommended. Attempts to install such seals on this gauge will void the warranty**

## Mid-West<sup>®</sup> Instrument

6500 Dobry Dr. Sterling Heights, MI 48314  
Ph: (586)254-6500 FAX (586)254-6509  
Toll Free: (800)648-5778  
E-Mail: [sales@midwestinstrument.com](mailto:sales@midwestinstrument.com)  
Web Page: [www.midwestinstrument.com](http://www.midwestinstrument.com)



# GAUGE ACCESSORIES

---



For Installation and Operation Manuals  
Please Visit: [www.midwestinstrument.com/literature](http://www.midwestinstrument.com/literature)

---

**Mid-West**  
Instrument



# Mid-West<sup>®</sup> Instrument

## 3 & 5 Valve Differential Pressure Manifolds



3 & 5 valve manifolds are designed for applications where direct mounting to an instrument is impractical or undesirable. The manifold is mounted to the lines from the instrument and signal rather than directly to instrument. Bubble tight shut-off, lightweight, super strong construction, compact designs that require less parts, chrome plated stems that prevent galling and stripping- these valves are built to perform under pressure. That's why in some of the most rigid tests, manifolds provided by Mid-West Instrument consistently meet or exceed industry standards.

- **Pressure rating:** 6000 PSIG (414 bar) @ 240°F (115°C)
- **Instrument Connections:** Std. 3 & 5 Valve = ½" FNPT / 3-Valve Mini-Manifold:= ¼" FNPT
- **Process Connections:** Std. 3 & 5 Valve = ½" FNPT / 3-Valve Mini-Manifold:= ¼" FNPT
- **Dust cap:** Protects spindle threads from dirt & dust.
- **Gland Nut & Lock Nut:** Adjusts the packing compression to provide leak free operation even on vacuum service.
- **Gland Packing:** PTFE packing and metal seal ring ensures leak free operation.
- **Bonnet:** Precisely machined bonnet adds a high level of reliability at maximum pressure & temperature while increasing valve life and protecting stem threads from atmospheric corrosion.
- **Isolated Stem threads:** Adjustable packing below stem ensures leak proof long service life
- **Less Parts:** Less leak points and less fugitive emissions.
- **Test Ports:** ¼" FNPT ports which may be used as test connections (#107470 & #107469) (#113343 Mini-manifold does not have test ports)

Teflon Packing, Integral (Body Material) Seat, and Stainless Steel Body

Model Number	Description
113343	3-Valve 316 S.S. Single Block Mini-Manifold (1/4" FNPT Connections)
107470	3-Valve 316 S.S. Single Block Manifold (1/2" FNPT Connections)
107469	5-Valve 316 S.S. Single Block Manifold (1/2" FNPT Connections)

**"Mid-West Instrument can supply many other manifolds that meet your specifications"**



# Manifold Dimensional Information

**#113343**  
**3-Valve Mini- Manifold**

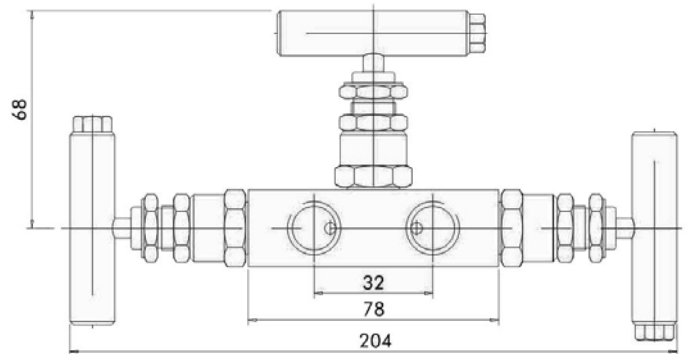
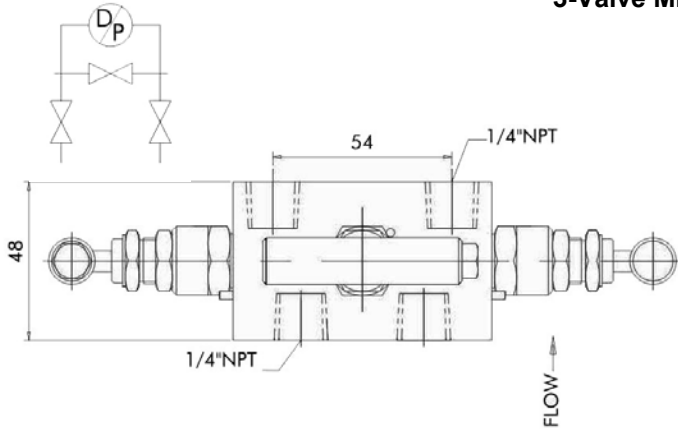

**#107470**  
**3-Valve Manifold**

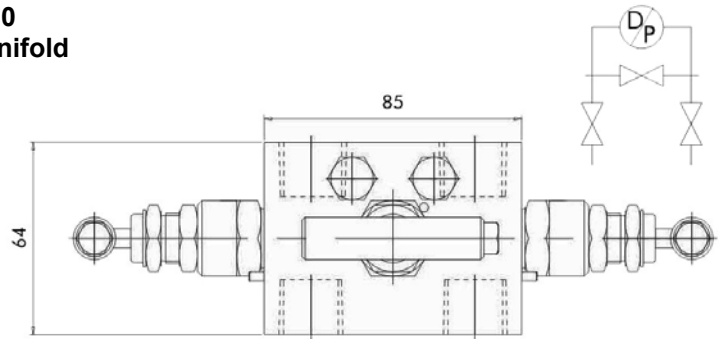
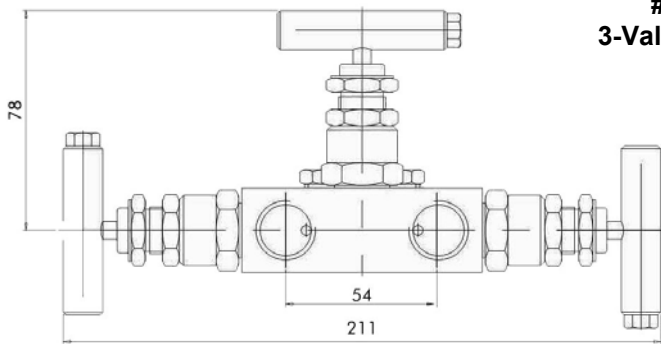

**#107469**  
**5-Valve Manifold**

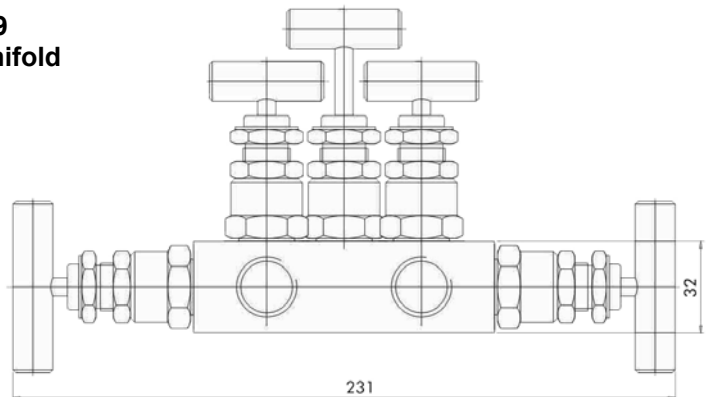
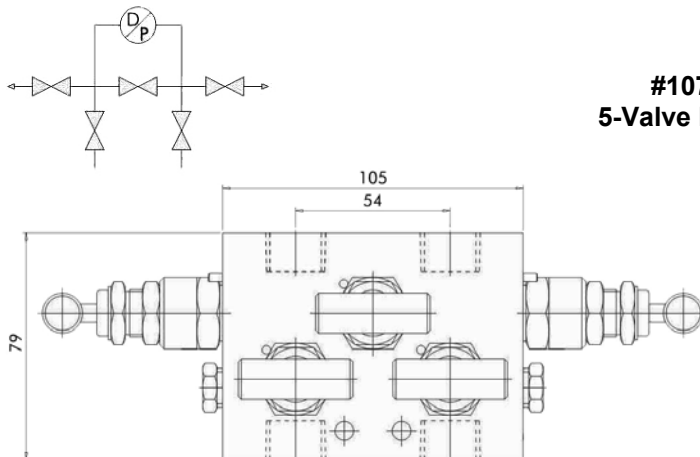

# Typical Manifold Installations

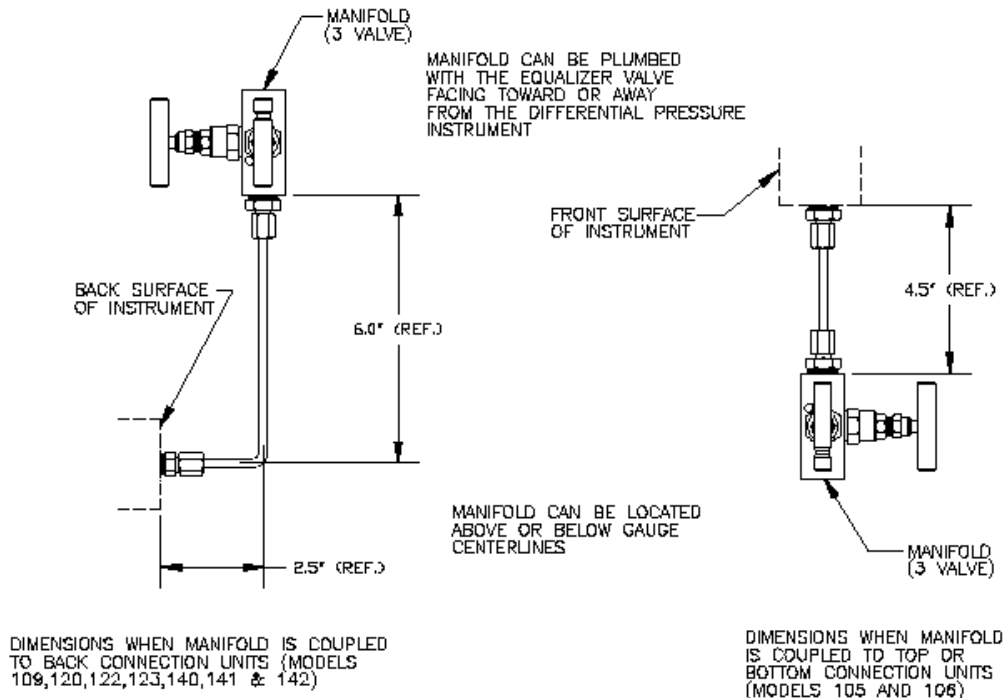

OTHER DIMENSIONS MAY BE AVAILABLE. CONSULT THE FACTORY.

Mid-West Instrument offers multi valve isolation manifolds that protect our differential pressure gauges, switches and transmitters. This allows the user to install a complete assembly saving installation time and transactional cost. Assembles can be custom designed to fit each specific application.

## Examples of Typical Manifold Installations





# Mid-West<sup>®</sup> Instrument

## Model 150 “VARI-DAMP” PULSATION DAMPENER



- Provides infinitely adjustable dampening
- Protects against surges and pressure shocks
- Use with all types of instruments and pressure gauges including differential pressure and compound

The Model 150 “Vari-Damp” all purpose pulsation dampener features both a fine thread adjustable needle valve for dampening characteristics and a precision ball check to block line surges, shock waves or fluid hammer. The Model 150 provides outstanding protection for applications where low displacement devices such as bourdon tube gauges or electronic transmitters are used or in high displacement devices where diaphragm, piston or bellows operated gauges, recorders or controllers are required. Double-ported instruments should be installed with a Model 150 on each input pressure line.

The Model 150 needle valve provides adjustable dampening characteristics by simply loosening the lock-nut on the adjusting screw and making a slight re-adjustment to the needle valve setting. Use of the Model 150 is preferred over other commercially available designs that feature several piston diameters or porous metal discs requiring removal and/or disassembly to re-adjust. The Model 150 adjustable needle valve can be used as a complete shutoff to facilitate changing out of a gauge or instrument. This method is not intended to replace instrument block valves as continual over-torquing could damage the valve seat.

The Model 150 ball check offers protection surge and/or pressure spikes as indicated in the black lines in the graphs. The 316 stainless steel ball is driven on seat by the pressure surge and held on seat as long as the differential pressure exists across the ball, while metering pressure to the instrument through a calibrated, groove across the ball seating area.

The Model 150 is available in Brass or 316 Stainless Steel with 1/4” or 1/2” NPT x FNPT connections

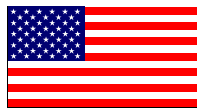
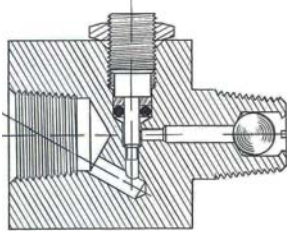

Made in the USA

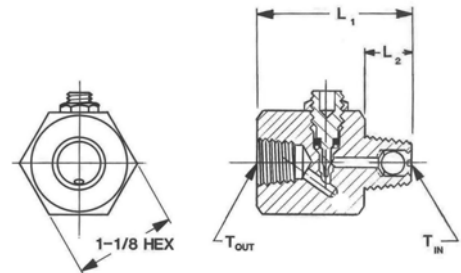

Model	Description	Thread Size	Body Material	L1 OAL Length (INCH)	L2 Thread Length (INCH)	MAX. W.P. PSIG (bar)	Weight OZ
150-BO	Male X Female NPT	1/4" NPT	Brass	1.73	.56	3,000 (204)	6
150-BH	Male X Female NPT	1/2" NPT	Brass	2.31	.75	5,000 (340)	8
150-SO	Male X Female NPT	1/4" NPT	316 S.S.	1.73	.56	5,000 (340)	6
150-SH	Male X Female NPT	1/2" NPT	316 S.S.	2.31	.75	10,000 (680)	8

## Standard Model Specification: 150-BO-00

3000 PSIG Working Pressure, Brass Body Material  
 1/4" FNPT X 1/4" MNPT Connections, Buna-N & Teflon Seals

**Mid-West Instrument**  
**1-800-648-5778**

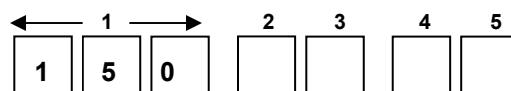

Basic Model



<b>2</b>	<b>Material (Body)</b>	
<b>B</b>	Brass	
<b>S</b>	316 Stainless Steel	
<b>Z</b>	Special ( <i>Un-coded Options</i> )	
<b>3</b>	<b>Size</b>	
<b>O</b>	1/4" FNPT X 1/4" MNPT	
<b>H</b>	1/2" FNPT X 1/2" MNPT	
<b>Z</b>	Special ( <i>Un-coded Options</i> )	
<b>4</b>	<b>Seal Materials / Temperature Range (Deg. F)</b>	
<b>0</b>	Buna-N & Teflon	-30° to +250°
<b>1</b>	Viton & Teflon	-15° to +400°
<b>2</b>	Neoprene & Teflon	-45° to +300°
<b>5</b>	Ethylene & Teflon	-70° to +250°
<b>9</b>	Special ( <i>Un-coded Options</i> )	
<b>5</b>	<b>Options</b>	
<b>0</b>	NONE	
<b>9</b>	Special ( <i>Un-coded Options</i> )	

**INSTALLATION:** Model 150 pulsation dampener can be installed directly on the instrument to be protected. The Model 150 features a built-in shutoff to allow instrument protection or removal. A shutoff valve in the line is not required. Avoid excessive force when closing to prevent seat galling.

**NOTE:** CAUTION TO BE EXERCISED WHEN ADJUSTING NEEDLE VALVE. DO NOT ADJUST MORE THAN TWO TURNS FROM CLOSED POSITION, LEAKAGE CAN ACCUR.

**MAINTENANCE:** The Model 150 can be cleaned by removing the needle adjusting screw, "O" Ring and Teflon backup ring. Metal parts should be cleaned in a commercial solvent.

# Mid-West<sup>®</sup> Instrument

## Model 200 “GAUGE MINDER”

### PRESSURE LIMITING VALVE



Aluminum  
Model 200



Brass  
Model 200

- **Pressure limiting valve prevents instrument over-range**
  - **Adjustable needle valve dampens pulsation**
- **Use with all types of instruments and pressure gauges**
  - **Can be mounted in any position**
- **Available in Aluminum, Brass, and 316 S.S.**

Model 200 “Gauge Minder” features a pressure limiting valve that blocks off excess pressure to the instrument, preventing calibration failure, internal damage, and “blow-out” from over-ranging - a principal cause of instrument failure.

Model 200 is supplied with a set of range springs designed to set the shutoff pressure point at any pressure from 50 to 5000 PSI. The automatic shutoff valve is positive on closing and is non-chattering. Once closed, pressure need only be reduced approximately 10% of set pressure to re-open the valve. The accuracy of the instrument used with the Model 200 is in no way affected up to the set point of the pressure shutoff.

Model 200 also features an adjustable needle valve designed to dampen system pulsation reducing instrument oscillation, improving readability, and extending instrument life without the addition of a snubber. Instrument reliability is improved and the cost to repair, re-calibrate, or replace the instrument is lowered. Operating safety is also enhanced.

Model 200 is available in Aluminum, Brass, or 316 Stainless Steel with 1/4” FNPT connections for 5000 PSI working pressure and in Brass or 316 Stainless Steel with 1/2” FNPT connections for 10,000 PSI working pressure. Buna N O-rings and Teflon backup rings are standard. Optional seal materials include Viton, Neoprene, and Ethylene Propylene.

The range springs are identified by color, as follows:

<b>Color of Spring</b>	<b>Shut-off Range, PSI</b>
Silver	50 to 120 PSI
Black	100 to 1100 PSI
Gold	1000 to 5000 PSI

Model	Process Connections	Thread Size	Body Material	Valve Shut-Off Pressure Range	MAX. W.P. PSIG (bar)	Approx. Weight
200-AO	Female x Female NPT	1/4" FNPT	Aluminum	50 to 5000 PSIG	5,000 (340)	.80 oz
200-BO	Female x Female NPT	1/4" FNPT	Brass	50 to 5000 PSIG	5,000 (340)	2.2 Lbs
200-BH	Female x Female NPT	1/2" FNPT	Brass	50 to 5000 PSIG	10,000 (680)	2.2 Lbs
200-SO	Female x Female NPT	1/4" FNPT	316 S.S.	50 to 5000 PSIG	5,000 (340)	1.25 Lbs
200-SH	Female x Female NPT	1/2" FNPT	316 S.S.	50 to 5000 PSIG	10,000 (680)	1.25 Lbs

# Model 200 “GAUGE MINDER” PRESSURE LIMITING VALVE



## INSTALLATION AND MAINTENANCE INSTRUCTIONS:

Model 200 “Gauge Minder” is mounted in-line with the instrument to be protected and may be mounted in any position. The automatic shutoff set point is adjusted by loosening the lock nut marked “adjust” and turning the adjustment screw. Turning “clock-wise” increases the shutoff pressure and turning “counter clock-wise” reduces the shutoff pressure. The Model 200 is shipped with a 50 to 120 PSI range spring installed, unless otherwise requested. Two additional springs for higher ranges are included as separate parts. The range spring can be changed by removing the adjustment screw.

The range springs are identified by color, as follows:

<u>Spring</u> Color of	<u>Range, PSI</u> Shut-off
Silver	50 to 120 PSI
Black	100 to 1100 PSI
Gold	1000 to 5000 PSI

The operating limits of the instrument to be protected must be considered when determining the point to set the Model 200 shutoff pressure. Commonly, a setting of 110% of full scale of the instrument is used. Instruments with full scale ranges above 1000 PSI generally have a lower safety factor. It is necessary in this instance to set the shutoff point to 100% of full scale of the instrument to prevent calibration failure. After adjustment of the shut-off pressure of the Model 200 is completed the instrument should be over-pressured for several minutes to verify operation. If indicated instrument pressure falls with the shut-off valve closed, there is a connection leak from the Model 200 to the instrument which must be corrected. If indicated instrument pressure rises beyond the shut-off point, the Model 200 is defective and should be returned if new or repaired by cleaning or installing new seals if previously used.

**CAUTION:** Do not adjust the set point with system pressurized and in the shutoff mode. Reduce system pressure until shutoff valve is open, then make set point adjustment.

Model 200 can be shut off manually with the needle valve marked “damp”. The lock nut must be loosened. The valve screw is turned “clock-wise” to close. Turning the valve screw “counter clock-wise” one turn from closed position gives a range of pulsation dampening. Adjust the amount of dampening necessary to stop pointer oscillation on the instrument.

**NOTE:** Caution must be exercised when adjusting needle valve. Do not adjust more than two turns from closed position. Leakage can occur.

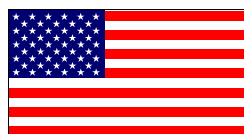

**Made in the USA**

## Standard Model Specification: 200-AO-00

5000 PSIG Working Pressure, Aluminum Body Material  
 1/4" FNPT X 1/4" MNPT Connections, Buna-N & Teflon Seals

**Mid-West Instrument**

**1-800-648-5778**

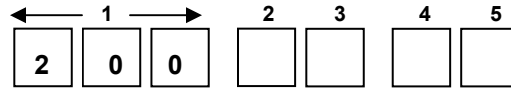

Basic Model



<b>2</b>	<b>Material (Body)</b>	
A	Aluminum	
B	Brass	
S	316 Stainless Steel	
Z	Special ( <i>Un-coded Options</i> )	
<b>3</b>	<b>Size</b>	
O	1/4" FNPT X 1/4" MNPT	
H	1/2" FNPT X 1/2" MNPT (Not available on Aluminum Body Material)	
Z	Special ( <i>Un-coded Options</i> )	
<b>4</b>	<b>Seal Materials / Temperature Range (Deg. F)</b>	
0	Buna-N & Teflon	-30° to +250°
1	Viton & Teflon	-15° to +400°
2	Neoprene & Teflon	-45° to +300°
5	Ethylene & Teflon	-70° to +250°
9	Special ( <i>Un-coded Options</i> )	
<b>5</b>	<b>Options</b>	
0	NONE	
7	Factory Preset Shutoff Point ( <b>Above 1500 PSIG</b> )	
8	Factory Preset Shutoff Point ( <b>Up to 1500 PSIG</b> )	
9	Special ( <i>Un-coded Options</i> )	

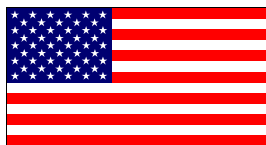

**Made in the  
USA**





# Mid-West<sup>®</sup> Instrument

## Diaphragm / Chemical Seals

**Diaphragm Seals (or Chemical Seals)** use a flexible barrier, or diaphragm, to isolate a pressure sensor (gauge, switch, transmitter, or transducer) from adverse effects of the process fluid.

### HOW IT WORKS:

A diaphragm seal, when properly mounted to its sensor and filled will accurately transmit process pressure to the instrument. Pressure exerted on the flexible diaphragm is transmitted hydraulically to the instrument through the fill fluid, which fills the void between the diaphragm and the instrument, (including the bourdon tube, in the case of a pressure gauge.)

### APPLICATION CONSIDERATIONS:

The following should be considered when choosing a diaphragm seal:

1. Process Characteristics: Pressure, temperature, (see tables, this page) chemical compatibility and viscosity.
2. Seal Mounting: Connection to process (threaded, flanged, clamped, in-line) Connection to instrument (usually NPT).
3. Ambient Characteristics: Temperature, corrosive atmosphere, etc.

4. Instrument Considerations: Sufficient fluid displacement is required to drive instrument through its full range (this means, for example, you can't put a large gauge on a small seal); remote instrument placement requires a capillary connecting instrument to seal.

5. Vacuum Considerations: High vacuums (over 25" Hg vac.) or vacuums with high temperatures require special fill selection, preparation, and procedures, as well as careful diaphragm selection.

**NOTE:** Improper selection may result in system failure and possible damage or injury. *Mid-West* can provide application assistance, but final compatibility is the responsibility of the buyer. Proper selection of seal can reduce or eliminate any additional system error caused by adding a Diaphragm Seal to your instrument.

### SEAL TYPES:

**Standard Seals (pages 2&3)** include Threaded off-line, threaded in-line, and flanged off-line types in many materials for a variety of applications:



**SPECIAL DESIGNS:** Mid-West is ready to work with you on any high-performance diaphragm seal application, (that might exceed the stated limit below) such as high vacuum, high temperature, high sterility, custom design or high static pressure with a low differential span, or high vacuum with high temperature.

### MATERIALS:

Lower housings: 316 S.S. is standard with a large selection to suit a wide variety of applications (see table 1, page 3)  
 Diaphragms: Standard metal diaphragms are convoluted and made of 316 S.S. Many other materials are available for corrosion resistance or extra sensitivity. (see table 6, page 3)  
 Gaskets: Standard gaskets are Teflon on the process side of diaphragm (Grafoil for hi temp.), and Viton on the fill side. Other materials are available.

Maximum Temperature	Diaphragm Material	Lower Housing
650°F	Welded Metal	Metal
450°F	Teflon	Metal
300°F	Viton	Metal
140°F	n/a	Nonmetal

	PSI	Lower Housing	
		Diaphragm	Size 5 Seal
<b>Maximum working pressure</b>	1,500	Metal, w/S.S. Bolting	(at 100°F)
	2,500	Metal, w/Std. Bolting	(at 100°F)
	5,000	Metal, w/Hi-Press. Bolting	(at 100°F)
	Per flange rating	ASA Flange	(Per Flange Spec)
	300	Non-Metalic	(at 140°F)
<b>Min. working pressure</b>	Metal	25 PSI	10 PSI
	Teflon	20 PSI	8" WC
	Viton	5" WC	N/A
<b>Vacuum Limits</b>	Metal	-21" hg	-24" hg
	Teflon	-23" hg	-26" hg
	Viton	-29" hg	N/A

# DIAPHRAGM SEALS

## How To ORDER

**TABLE 1 Seal Series**    **TABLE 2 Seal Size**    **TABLE 3 Configuration**    **TABLE 4 Instrument Connection**    **TABLE 5 Process Connection**    **TABLE 6 Diaphragm Material**    **TABLE 7 Lower (process) Housing Material**    **TABLE 8 Upper (instrument) Housing Material**



**TABLE 1 Seal Series**

- W** - Welded metal diaphragm
- T** - Teflon diaphragm (high sensitivity, chemical resistance)
- V** - Viton diaphragm - (most sensitive, for low pressures)

**TABLE 2 Seal Size**

- 5** - Standard size  
Seal dia. = 3.25" in threaded models  
Diaphragm dia. = 2.25"
- 6** - Large size - (Preferred for low pressure, hi displacement, or hi sensitivity.)  
Seal dia. = 4" in threaded models  
Diaphragm dia. = 3"
- 7** - Large size  
Seal diameter; 5.2"  
Diaphragm dia. = 4.1"

**TABLE 4 Instrument Connection**

- 4** - 1/4" NPTF
- 2** - 1/2" NPTF

**TABLE 5 Process Connection**

- 4** - 1/4" NPTF
- 2** - 1/2" NPTF
- 3** - 3/4" NPTF
- 1** - 1" NPTF
- F** - Flanged - specify flange size and pressure rating (e.g. 1 1/2", 150 lb) or insert "V" codes from Table A see p. 24 (e.g. V41=1 1/2" 150#)

### Threaded, Off-Line

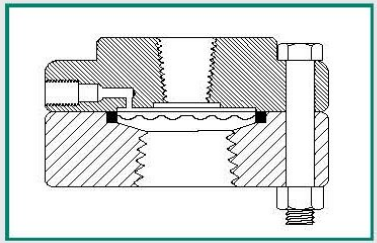

### TABLE 3 - Configuration

- 10** - Replaceable diaphragm - non cleanout (not available with series "W")
- 11** - Same as 10, with flush port
- 15** - Cleanout style - lower housing can be removed without losing fill. (Available with Series W, T, V)
- 16** - Same as 15, with flush port

### Flanged, Off-Line - with cleanout

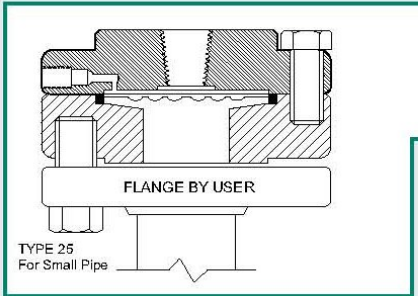

- 25** - for 1/2", 3/4" pipe size (1" in size 6)
- 26** - Same as 25, with flush port
- 30** - for 1 1/2" pipe to 3" pipe size (1" in size 5)
- 31** - Same as 31, with flush port

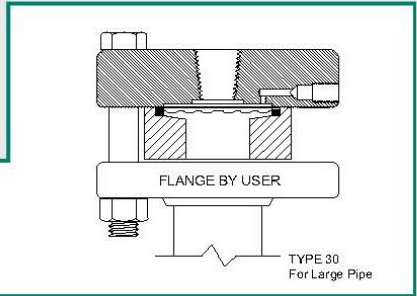

### In-Line, Flow-Thru - with cleanout

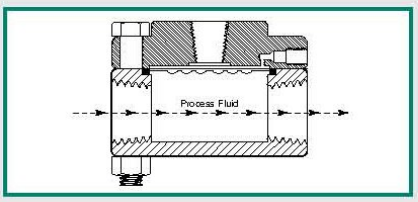

- 35** - Threaded (shown) - for 1/4" to 1" pipe
- 40** - Socket Weld - for 1/4" to 1" pipe
- 45** - Saddle Weld - for 1" to 8" pipe
- 50** - Butt Weld - for 1" to 12" pipe

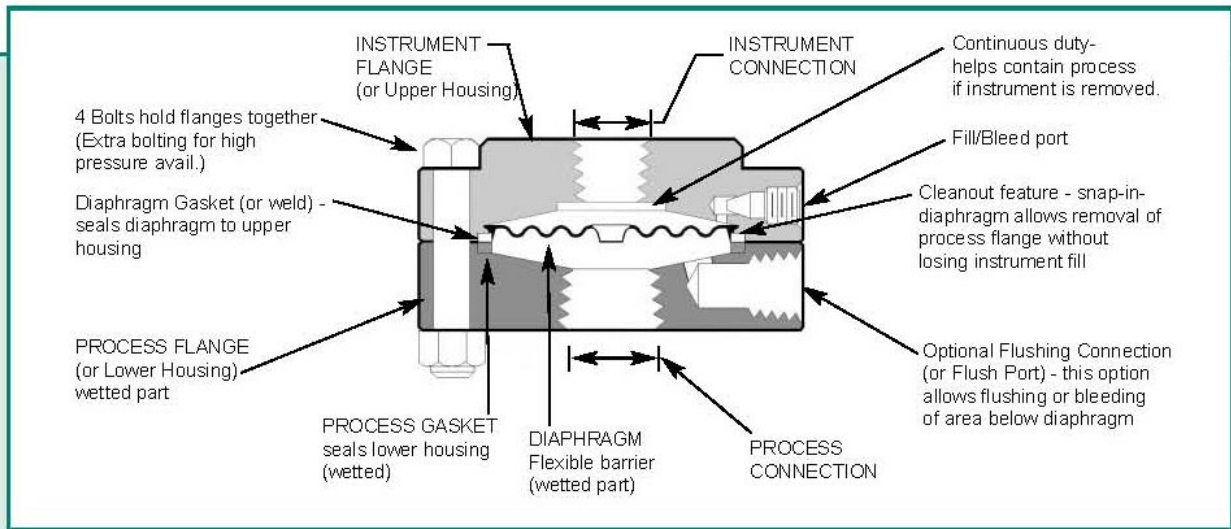

**TABLE 6**  
**Diaphragm Material (wetted)**

MOST COMMON

S - 316 S.S.
T - Teflon
*V - Viton

D - Carpenter 20  
 \*F - 304 S.S.  
 G - Hastelloy B  
 H - Hastelloy C  
 J - Titanium  
 L - 316LSS, teflon coated  
 M - Monel  
 N - Nickel  
 U - Tantalum  
 X - Gold Plated Diaphragm  
 \*Y - Inconel  
 \*Size 5 only.

**TABLE 7**  
**Lower Housing Material (wetted)**

MOST COMMON

S - 316 S.S.	H - Hastelloy C-276
T - Teflon	J - Titanium
*L - Teflon lined	K - Kynar
Z - PVC	M - Monel
B - Brass	N - Nickel
C - Steel	P - Polypropylene
D - Carpenter 20	U - Tantalum
F - 304 S.S.	UL - Tantalum Lined
G - Hastelloy B	W - CPVC
	Y - Inconel

\*Available only on types 25 & 30, 1" and larger.

**TABLE 8**  
**Upper Housing Material (including bolts)**

C - Carbon Steel (standard)
S - 316 Stainless
F - 304 Stainless

**OPTIONS:**

- Hi Pressure bolting
- Non-Stick Teflon coating on metal diaphragm
- Socket weld connections
- High temp. gasketing
- Stainless steel bolting (reduces pressure rating up to 50%)
- Capillary Lines

**Fill Fluids** Fill Fluids should be chosen with care. The fluid must be compatible with the process medium in case the diaphragm is ruptured. Compatibility of fill fluid with process is the user's responsibility.

FLUID	TEMPERATURE LIMITS	VISCOSITY, CS. 77° F	NOTES
Silicone, DC 200	-50 to 450° F	20	our standard fill
Silicone, DC 704	+50 to 600° F	44	Hi-temp fill
Silicone, DC 710	+30 to 700° F	500	Hi-temp fill
Neobee M-20	-4 to 320° F	10	food grade
Glycerin	+30 to 300° F	1110	for food; not recomb. for capillary
Halocarbon	-40 to 400° F	6	inert, for use with oxidizers (must not contact Al, Mg)

Other fills available: consult factory.

*not to be used with strong oxidizers, such as chlorine, oxygen, etc.*

Credits: Viton, Teflon, Kynar, TM DuPont, Inc.; Carpenter 20 - TM Carpenter Steel Co.; Inconel, Monel - TM Huntington Alloys, Inc.; Hastelloy - TM Cabot Corp.; Halocarbon - TM Halocarbon Corp.

# Mid-West<sup>®</sup> Instrument

## Diaphragm Seal Worksheet

### **CUSTOMER INFORMATION:**

- Company Name: \_\_\_\_\_
- Address \_\_\_\_\_
- Contact: \_\_\_\_\_
- Phone number: \_\_\_\_\_
- Email address: \_\_\_\_\_
- Date: \_\_\_\_\_

### **PROCESS INFORMATION:**

- Process Temperature Range: \_\_\_\_\_
- Ambient Temperature Range: \_\_\_\_\_
- Process Fluid/Media: \_\_\_\_\_
- Current Pipe/Tank Material: \_\_\_\_\_
- Maximum Pressure on Seal: \_\_\_\_\_
- Differential Pressure Range: \_\_\_\_\_
- Working Pressure on Seal: \_\_\_\_\_
- Other (vibration, pulsation, etc.): \_\_\_\_\_

### **SEAL INFORMATION:**

- Mounting - Direct or Remote: \_\_\_\_\_
- (if remote) Capillary Length: \_\_\_\_\_
- Process Connection: \_\_\_\_\_
- Required date for completed seal assembly? \_\_\_\_\_

### **MIDWEST DIFFERENTIAL GAUGE INFORMATION:**

Model number used in application: \_\_\_\_\_  
Quantity of differential gauges used in application: \_\_\_\_\_

### **ADDITIONAL NOTES:**

---

---

---

---

---

---